

PFC-302L16



Powered Fiber Cable, OM3, 2 Fibers, Indoor/Outdoor, 16AWG Conductor, meter, feet

- Easy peel, stranded conductors for maximum cable flexibility and rapid access
- Polarization indentation along one side of the cable for polarity identification
- No special tools or mounting hardware required - usage of a standard "FTTH" pressure clamp for aerial installation
- Easy split of cable into three separate sections for separate routing in closures, as needed for installation
- Riser/LSZH jacket for indoor/outdoor applications

Product Classification

Regional Availability

Asia | Australia/New Zealand | EMEA | Latin America | North America

Product Type

Hybrid cable, fiber and power

Ordering Note

Minimum order quantity is 500 meter

General Specifications

Cable Type

Stranded indoor/outdoor

Fiber Short Description

PFC-L16

Jacket Color

Black

Total Fiber Count

2

Dimensions

Height Over Jacket

4.318 mm | 0.17 in

Width Over Jacket

11.43 mm | 0.45 in

Conductor Gauge

16 AWG

Outline Drawing

PFC-302L16

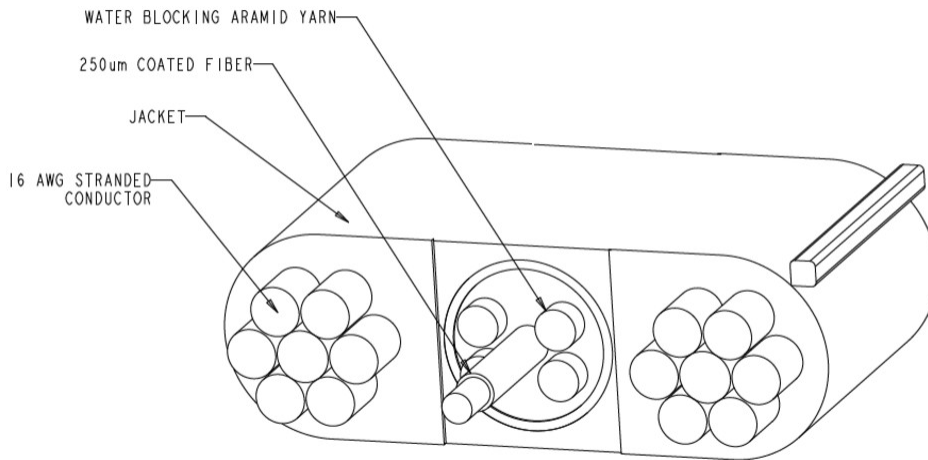

Mechanical Specifications

Minimum Bend Radius, loaded	88.9 mm 3.5 in
Minimum Bend Radius, unloaded	45.72 mm 1.8 in
Tensile Load, long term, maximum	133.447 N 30 lbf
Tensile Load, short term, maximum	440.374 N 99 lbf
Vertical Rise, maximum	122.011 m 400.3 ft

Optical Specifications

Fiber Type	OM3, bend insensitive
-------------------	-----------------------

Environmental Specifications

Installation temperature	-10 °C to +60 °C (+14 °F to +140 °F)
Operating Temperature	-40 °C to +70 °C (-40 °F to +158 °F)
Storage Temperature	-40 °C to +70 °C (-40 °F to +158 °F)
Cable Qualification Standards	Telcordia GR-20-CORE Issue 4
EN50575 CPR Cable EuroClass Fire Performance	Dca
EN50575 CPR Cable EuroClass Smoke Rating	s1a
EN50575 CPR Cable EuroClass Droplets Rating	d1
EN50575 CPR Cable EuroClass Acidity Rating	a1
Environmental Space	Low Smoke Zero Halogen (LSZH) Riser

PFC-302L16

Flame Test Method

IEC 60332-1-2 | IEC 60754-2 | IEC 61034-2 | NFPA 130 | UL 1666 | UL 444

Jacket UV Resistance

UV stabilized

Packaging and Weights

Cable weight

69.944 kg/km | 47 lb/kft

Regulatory Compliance/Certifications

Agency

Classification

CENELEC

EN 50575 compliant, Declaration of Performance (DoP) available



Included Products

- CS-5E-PFC – 50µm OM3 Bend-Insensitive Multimode Fiber