



Multi-tenant Data Center System Selection Guide

For use in the Asia-Pacific Region

COMMSCOPE®





INTRODUCTION

Turn your multi-tenant data center (colocation) infrastructure into a competitive advantage

The multi-tenant data center (MTDC) arena is not for the faint of heart. Growth is explosive, the pace of change frenetic, and competition fierce. Driven by the growth of edge-based connectivity and new partnerships with hyperscale and cloud providers, the global colocation and wholesale market is projected to exceed \$54 billion in revenue by 2023, compared to \$38.2 billion in 2018.¹

To compete successfully, MTDC owners and network managers need to be quick to market, globally agile and able to scale on demand. It all comes down to having a physical layer infrastructure designed for fast deployment, simplified management and flexible growth.

The fiber-dense connectivity customers want—the scalability and support you need

Today's colocation and wholesale tenants are running faster, more demanding applications than ever before. They look to you for a fiber-dense backbone and flexible connectivity. That's why some of the world's largest MTDC providers look to CommScope.

With a world-leading portfolio of carrier-grade fiber connectivity and management solutions for the backbone and copper and fiber structured cabling solutions, we help you manage the exponential growth in your MTDC. From entrance facilities and cross-connects to the meet-me rooms and customer cages, CommScope supports the fiber-dense applications and migration agility you and your customers depend on.

Connections beyond the obvious

We also keep you connected in other ways. Our powered fiber cabling solution remotely connects and powers a wide range of IP devices, nodes and sensors, while the FiberGuide® optical raceway solution connects, manages, distributes and protects your fiber plant across all areas of the data center. With CommScope's global manufacturing network and CommScope Express expedited delivery service, the world's most advanced fiber and copper connectivity solutions are never more than a week away from their final destination. So, you can satisfy your most demanding customers, wherever they are.

For MTDCs, future success starts with an adaptable, powerful and streamlined infrastructure. CommScope turns yours into a compelling and competitive advantage. Read on to learn how.

To compete successfully, MTDC owners and network managers need to be quick to market, globally agile and able to scale on demand.

¹ Global Colocation and Wholesale Datacenter Market to Exceed \$54 Billion by 2023; 451 Research; April 25, 2019.



Direct System Selection

Fiber Splice Systems	5	Fiber Cable Fixing Accessories.	32
Fiber Entrance Box (BUDI)	6	Field Installable Fiber Connectors.	33
Fiber Entrance Box (BUDI) System Selection	7	Singlemode Patch Cord and Cable Management Products	34
Fiber Entrance Box (BUDI) Products.	8	Pre-terminated Fiber Systems	35
FACT® Optical Distribution Frame (ODF)	10	Pre-terminated 19-in. Fiber	36
FACT® Optical Distribution Frame (ODF) Modular Design	11	Pre-terminated 19-in. Fiber System Selection	36
FACT® Optical Distribution Frame (ODF) Products	12	Pre-terminated 19-in. Fiber System Products	37
Select BUDI and FACT Splice Products and Accessories.	14	Pre-terminated 19-in. Fiber System Cable Assemblies	41
Universal Mount Splice Cabinet (UMSC)	15	Pre-terminated FACT ODF Fiber	45
Universal Mount Splice Cabinet (UMSC) System Selection	16	Pre-terminated FACT ODF Fiber System Selection	45
Universal Mount Splice Cabinet (UMSC) Products	17	Pre-terminated FACT ODF Fiber System Products	46
Flex Frame ODF and 19-in. Propel Panels	18	Pre-terminated FACT ODF Fiber System Cable Assemblies.	47
Flex Frame ODF System Selection	19	FiberGuide® Raceway Systems	50
Flex Frame ODF Products	20	Cable Management Wire Baskets	54
FOSC® 600 Series	21	Category 6A Systems	56
FOSC® 600 Series System Selection and Products.	22	Powered Fiber Systems	58
19-in. Splice Solutions	23	DIN Rail Solutions for BMS Networks	61
19-in. Splice Solutions System Selection	23	Fiber Wall Boxes for Fiber Entrance Applications	64
19-in. Splice Solutions Products.	24	2 Post Equipment Racks and Accessories	66
FMS Termination and Splice Panel.	25	CommScope’s imVision® Platform	68
Singlemode High Fiber Count Bulk Cables	26		
Rollable Ribbon Fiber Solutions	27		
Rollable Ribbon Fiber Technology	28		
Singlemode Rollable Ribbon and Stranded Fiber Cables	29		
Other Products	31		
Indoor and Indoor/Outdoor Micro-sheath Cables Suitable for FACT.	31		

Architecture System Selection

Colocation Campus and Building Infrastructure	70	Reference Designs and Technical Information	85
Overview	71	MDA Cabinet	86
Fiber Entrance and Meet-Me Room	72	MDA Cross-connect 19-in.	87
High Fiber Count DC Interconnect	73	MDA Cross-connect FACT ODF	88
Campus Cabling	74	IDF FACT	89
Building Cabling	75	IDF 19-in.	90
IDF to Customer Cage (FACT ODF)	76		
IDF to Customer Cage (19-in. Cabinet)	77		
Campus Cabling for Wi-Fi and Security	78		
Customer Space Cabling Infrastructure	79		
Overview	80		
Main Distribution Area (MDA) Fiber	81		
Equipment Distribution Area (EDA) Fiber	82		
Equipment Distribution Area (EDA) Copper	83		
FiberGuide® Raceway Systems	84		



Fiber Splice Systems

Fiber Entrance Box (BUDI)

FACT® Optical Distribution Frame (ODF)

Universal Mount Splice Cabinet (UMSC)

Flex Frame ODF and 19-in. Propel Panels

FOSC® 600 Series

19-in. Splice Solutions

Rollable Ribbon Fiber Solutions

Other Products



CommScope's BUDI portfolio of wall-mounted, indoor and outdoor fiber boxes is a modular and configurable platform for building entrance deployments. Available in a large variety of models to meet the needs of a wide range of applications, it offers rugged environmental protection; is UL listed, UV resistant, and IP54 rated and is designed for easy installation and accessibility.

The CommScope BUDI family is ideal for small to medium size buildings. It provides a flexible fiber management system for transitioning outside plant cable to indoor cable via splicing or with connectorized cable assemblies. It incorporates proven fiber routing procedures, cable termination accessories and splice trays resulting in consistent, high-quality fiber management. The BUDI portfolio offers the flexibility to address the needs of today's and tomorrow's fiber networks while maintaining commonality of components and operational practices.

Features and benefits

- Indoor or indoor/outdoor (IP54) rugged termination point
- UL listed and UV resistant enclosure
- Wide range of cable size supported
 - Optional lockable accessory available
 - Drop cables up to 0.19-inch diameter, round or flat
 - Feeder cables up to 1.02-inch diameter
 - Protective cable skirts available
 - Wrap-around cable ports
- Splice only and splice and patch versions
 - Indoor/outdoor riser cable with stranded or ribbon fiber
 - Available cable capacity with 24 or 48 fibers



Wall-mounted, indoor and outdoor fiber boxes for transitioning outside plant cable to indoor cable

Direct System Selection Index

BUDI	FACT ODF	UMSC	Flex Frame ODF, 19-in. Propel	FOSC 600	19-in. Splice	Rollable Ribbon Fiber	Other Products	Pre-term 19-in. Fiber	Pre-term FACT ODF Fiber	FiberGuide	Cable Mgmt Wire Baskets	Category 6A	Powered Fiber	DIN Rail	Fiber Wall Boxes	2 Post Equipment	imVision
------	----------	------	-------------------------------	----------	---------------	-----------------------	----------------	-----------------------	-------------------------	------------	-------------------------	-------------	---------------	----------	------------------	------------------	----------

Architecture System Selection Index

Colocation Campus and Building Infrastructure						Customer Space Cabling Infrastructure					Reference Designs and Technical Information						
Fiber Entrance, Meet-Me Room	High Fiber Count DC Interconnect	Campus Cabling	Building Cabling	IDF to Customer Cage (FACT ODF)	IDF to Customer Cage (19-in. Cabinet)	Campus Cabling for Wi-Fi and Security	MDA Fiber	EDA Fiber	EDA Copper	FiberGuide	MDA Cabinet	MDA Cross-connect 19-in.	MDA Cross-connect FACT ODF	IDF FACT	IDF 19-in.		

Select a product for more information.



FIST® Splice Sub-assembly Kit



SMOUV Splice Protectors



Meet-Me Room



Indoor or Indoor/
Outdoor Fiber Cable



Fiber Entrance Box



Outdoor
Fiber Cable

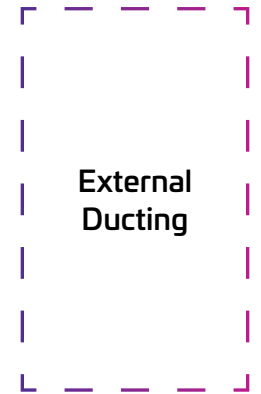

External Ducting



BUDI Seal Kit

Direct System Selection Index

BUDI	FACT ODF	UMSC	Flex Frame ODF, 19-in. Propel	FOSC 600	19-in. Splice	Rollable Ribbon Fiber	Other Products	Pre-term 19-in. Fiber	Pre-term FACT ODF Fiber	FiberGuide	Cable Mgmt Wire Baskets	Category 6A	Powered Fiber	DIN Rail	Fiber Wall Boxes	2 Post Equipment	imVision
------	----------	------	-------------------------------	----------	---------------	-----------------------	----------------	-----------------------	-------------------------	------------	-------------------------	-------------	---------------	----------	------------------	------------------	----------

Architecture System Selection Index

Colocation Campus and Building Infrastructure

Fiber Entrance, Meet-Me Room	High Fiber Count DC Interconnect	Campus Cabling	Building Cabling	IDF to Customer Cage (FACT ODF)	IDF to Customer Cage (19-in. Cabinet)	Campus Cabling for Wi-Fi and Security	MDA Fiber	EDA Fiber	EDA Copper	FiberGuide	MDA Cabinet	MDA Cross-connect 19-in.	MDA Cross-connect FACT ODF	IDF FACT	IDF 19-in.
------------------------------	----------------------------------	----------------	------------------	---------------------------------	---------------------------------------	---------------------------------------	-----------	-----------	------------	------------	-------------	--------------------------	----------------------------	----------	------------

Customer Space Cabling Infrastructure

Reference Designs and Technical Information



Review Fiber Entrance Box (BUDI) System Selection [here](#).

BUDI Wall Box, Splice Trays Not Included	Dimensions	Number of Splices	Number of Cable Entry Points (Bottom)	Max Number of FO Cables Per (Bottom) Entry Point	Mounting	Description Code	Part Number
BUDI Fiber Optic Wall mount Enclosure, empty for holding FIST Splice Trays, without lock	Height: 480 mm 18.898 in Height with cover: 550 mm 21.654 in Width: 360 mm 14.173 in Depth: 175 mm 6.89 in	432	4	24 (5.0mm OD) 24 (7mm OD) 6 (10mm OD) 6 (15mm OD) 3 (20mm OD)	Wall	BUDI-M-SP-A	CS8162-000
BUDI Fiber Optic Wall mount Enclosure, empty for holding FIST Splice Trays, with lock	Height: 480 mm 18.898 in Height with cover: 550 mm 21.654 in Width: 360 mm 14.173 in Depth: 175 mm 6.89 in	432	4	24 (5.0mm OD) 24 (7mm OD) 6 (10mm OD) 6 (15mm OD) 3 (20mm OD)	Wall	BUDI-M-SP-B	CU1193-000
BUDI Fiber Optic Wall mount Enclosure, empty for holding FIST Splice Trays, no lock	Height: 425 mm 16.732 in Height with cover: 500 mm 19.685 in Width: 295 mm 11.614 in Depth: 145 mm 5.709 in	336	3	24 (5.0mm OD) 24 (7mm OD) 4 (10mm OD) 4 (15mm OD) 2 (20mm OD)	Wall	BUDI-S-SP-A	CS1755-000
BUDI Fiber Optic Wall mount Enclosure, empty for holding FIST Splice Trays, with lock	Height: 425 mm 16.732 in Height with cover: 500 mm 19.685 in Width: 295 mm 11.614 in Depth: 145 mm 5.709 in	336	3	24 (5.0mm OD) 24 (7mm OD) 4 (10mm OD) 4 (15mm OD) 2 (20mm OD)	Wall	BUDI-S-SP-B	CS2130-000
Splicing Accessories	Fiber Type	Number of Splices Per Tray	Number of Trays	Total Fiber Count	Max Number Per BUDI	Description Code	Part Number
FIST Splice Sub-assembly kit with 8 slim element trays, each for holding up to 12 primary coated fibers, with Heat Shrink type splice holder	Primary Coated Stranded	12	8	96	x4 (BUDI-M) x3 (BUDI-S)	FIST-SOSA2-8SLE-S	CU5584-000
FIST Splice Sub-assembly kit with 6 slim element trays, each for holding up to 12 primary coated fibers, with Heat Shrink type splice holder	Primary Coated Stranded	12	6	72	x6 (BUDI-M) x4 (BUDI-S)	FIST-SOSA2-6SLE-S	760248821
FIST Splice Sub-assembly kit with 4 slim element trays, each for holding up to 12 primary coated fibers, with Heat Shrink type splice holder	Primary Coated Stranded	12	4	48	x9 (BUDI-M) x7 (BUDI-S)	FIST-SOSA2-4SLE-S	CU5583-000
SMOUV Fiber Optic Splice Heat Shrink Protective Sleeve for FIST Trays, pack of 100 pcs						SMOUV-1120-02	103897-000

Direct System Selection Index

BUDI	FACT ODF	UMSC	Flex Frame ODF, 19-in. Propel	FOSC 600	19-in. Splice	Rollable Ribbon Fiber	Other Products	Pre-term 19-in. Fiber	Pre-term FACT ODF Fiber	FiberGuide	Cable Mgmt Wire Baskets	Category 6A	Powered Fiber	DIN Rail	Fiber Wall Boxes	2 Post Equipment	imVision
------	----------	------	-------------------------------	----------	---------------	-----------------------	----------------	-----------------------	-------------------------	------------	-------------------------	-------------	---------------	----------	------------------	------------------	----------

Architecture System Selection Index

Colocation Campus and Building Infrastructure

Fiber Entrance, Meet-Me Room	High Fiber Count DC Interconnect	Campus Cabling	Building Cabling	IDF to Customer Cage (FACT ODF)	IDF to Customer Cage (19-in. Cabinet)	Campus Cabling for Wi-Fi and Security	MDA Fiber	EDA Fiber	EDA Copper	FiberGuide	MDA Cabinet	MDA Cross-connect 19-in.	MDA Cross-connect FACT ODF	IDF FACT	IDF 19-in.
------------------------------	----------------------------------	----------------	------------------	---------------------------------	---------------------------------------	---------------------------------------	-----------	-----------	------------	------------	-------------	--------------------------	----------------------------	----------	------------

Customer Space Cabling Infrastructure

Reference Designs and Technical Information



Review Fiber Entrance Box (BUDI) System Selection [here](#).

Sealing Kits	Sealing Kits	FO Cable OD	Description Code	Part Number
BUDI Fiber Optic Wrap around Cable Sealing Kit for up to 24 cables with max 5 mm cable diameter	BUDI-M	5 mm	BUDI-M-SEAL-24x5	CS6980-000
BUDI Fiber Optic Wrap around Cable Sealing Kit for up to 24 cables with max 7 mm cable diameter	BUDI-M	7 mm	BUDI-M-SEAL-24x7	CY1074-000
BUDI Fiber Optic Cable Sealing Kit for up to 6 cables with 10 mm cable diameter	BUDI-M	10 mm	BUDI-M-SEAL-6x10	CS6977-000
BUDI Fiber Optic Cable Sealing Kit for up to 6 cables with 15 mm cable diameter	BUDI-M	15 mm	BUDI-M-SEAL-6x15	CS6978-000
BUDI Fiber Optic Wrap around Cable Sealing Kit for up to 3 cables with max 20 mm cable diameter	BUDI-M	20 mm	BUDI-M-SEAL-3x20	CS6979-000
BUDI Fiber Optic Wrap around Cable Sealing Kit for up to 24 cables with max 5 mm cable diameter	BUDI-S	5 mm	BUDI-S-SEAL-24x5	CS3620-000
BUDI Fiber Optic Wrap around Cable Sealing Kit for up to 24 cables with max 7 mm cable diameter	BUDI-S	7 mm	BUDI-S-SEAL-24x7	CS5059-000
BUDI Fiber Optic Wrap around Cable Sealing Kit for up to 4 cables with a max cable diameter of 10 mm	BUDI-S	10 mm	BUDI-S-SEAL-4x10	CS1388-000
BUDI Fiber Optic Wrap around Cable Sealing Kit for up to 4 cables with a cable diameter of max 15 mm	BUDI-S	15 mm	BUDI-S-SEAL-4x15	CS1389-000
BUDI Fiber Optic Wrap around Cable Sealing Kit for up to 2 cables with a cable diameter of max 20 mm	BUDI-S	20 mm	BUDI-S-SEAL-2x20	CS1390-000

Direct System Selection Index

BUDI	FACT ODF	UMSC	Flex Frame ODF, 19-in. Propel	FOSC 600	19-in. Splice	Rollable Ribbon Fiber	Other Products	Pre-term 19-in. Fiber	Pre-term FACT ODF Fiber	FiberGuide	Cable Mgmt Wire Baskets	Category 6A	Powered Fiber	DIN Rail	Fiber Wall Boxes	2 Post Equipment	imVision
------	----------	------	-------------------------------	----------	---------------	-----------------------	----------------	-----------------------	-------------------------	------------	-------------------------	-------------	---------------	----------	------------------	------------------	----------

Architecture System Selection Index

Colocation Campus and Building Infrastructure

Fiber Entrance, Meet-Me Room	High Fiber Count DC Interconnect	Campus Cabling	Building Cabling	IDF to Customer Cage (FACT ODF)	IDF to Customer Cage (19-in. Cabinet)
------------------------------	----------------------------------	----------------	------------------	---------------------------------	---------------------------------------

Customer Space Cabling Infrastructure

Campus Cabling for Wi-Fi and Security	MDA Fiber	EDA Fiber	EDA Copper	FiberGuide
---------------------------------------	-----------	-----------	------------	------------

Reference Designs and Technical Information

MDA Cabinet	MDA Cross-connect 19-in.	MDA Cross-connect FACT ODF	IDF FACT	IDF 19-in.
-------------	--------------------------	----------------------------	----------	------------



Frame

The FACT optical distribution frame solution begins with CommScope’s modular, lightweight FACT frame. Designed modularly with a small footprint, the fully front accessible FACT frame can be placed up against a wall, or back-to-back in a quad formation to maximize usable density. The frame provides dedicated spots for cable routing and color-coded fiber management, supporting up to 2,880 LC connections in a single frame.

The cross-connect FACT frame can be designed and easily installed with cable routing on either side of the frame, which includes backplate numbering—allowing for simple tracking of fibers whether you route from top to bottom or vice versa. One standard patch cord length can reach any position in a back-to-back configuration, reducing the number of cable lengths required.

The FACT frame accommodates not only FACT shelving, but standard 19-in. shelving as well, allowing you to increase your density while utilizing your current equipment. The FACT

frame is compatible with a range of accessories such as side panels, doors and cable attachment plates.

Elements and chassis

FACT elements may be deployed individually as a single-element chassis or grouped with other elements for higher density solutions. Each element measures 30.95 mm (1.22 in) tall, 30 percent less than the standard HU (44.45 mm/1.75 in). Each element supports two hinged trays that provide full front access to both sides of all connections and clear visibility of all ports. Four chassis types—patch-only, patch-splice, pre-cabled and NG4—enable customization of the FACT optical distribution frame to support virtually any application.

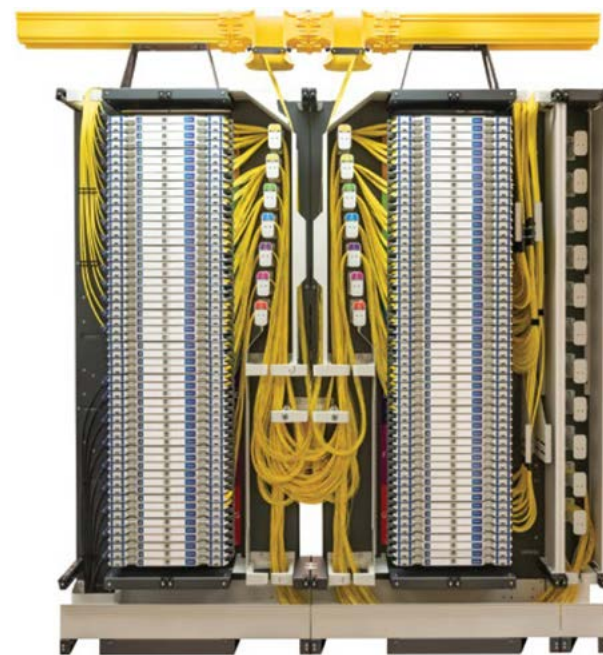

[Learn more about the FACT High Density ODF Solution here.](#)

Direct System Selection Index

BUDI	FACT ODF	UMSC	Flex Frame ODF, 19-in. Propel	FOSC 600	19-in. Splice	Rollable Ribbon Fiber	Other Products	Pre-term 19-in. Fiber	Pre-term FACT ODF Fiber	FiberGuide	Cable Mgmt Wire Baskets	Category 6A	Powered Fiber	DIN Rail	Fiber Wall Boxes	2 Post Equipment	imVision
------	----------	------	-------------------------------	----------	---------------	-----------------------	----------------	-----------------------	-------------------------	------------	-------------------------	-------------	---------------	----------	------------------	------------------	----------

Architecture System Selection Index

Colocation Campus and Building Infrastructure

Fiber Entrance, Meet-Me Room	High Fiber Count DC Interconnect	Campus Cabling	Building Cabling	IDF to Customer Cage (FACT ODF)	IDF to Customer Cage (19-in. Cabinet)	Campus Cabling for Wi-Fi and Security	MDA Fiber	EDA Fiber	EDA Copper	FiberGuide	MDA Cabinet	MDA Cross-connect 19-in.	MDA Cross-connect FACT ODF	IDF FACT	IDF 19-in.
------------------------------	----------------------------------	----------------	------------------	---------------------------------	---------------------------------------	---------------------------------------	-----------	-----------	------------	------------	-------------	--------------------------	----------------------------	----------	------------

Customer Space Cabling Infrastructure

Reference Designs and Technical Information



Select a product for more information.

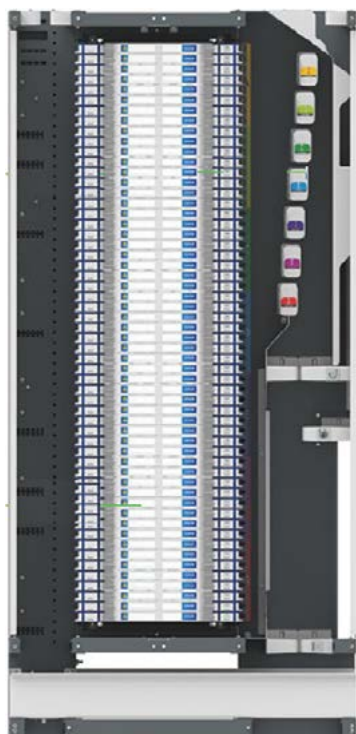

FACT Optical Distribution Frame



FACT Splice Chassis

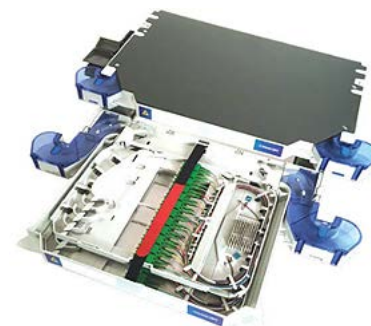

FACT Splice/Patch Chassis



Uniboot singlemode LC patchcords

Learn more about the **FACT ODF** for the APAC region [here](#).

Direct System Selection Index

BUDI	FACT ODF	UMSC	Flex Frame ODF, 19-in. Propel	FOSC 600	19-in. Splice	Rollable Ribbon Fiber	Other Products	Pre-term 19-in. Fiber	Pre-term FACT ODF Fiber	FiberGuide	Cable Mgmt Wire Baskets	Category 6A	Powered Fiber	DIN Rail	Fiber Wall Boxes	2 Post Equipment	imVision
------	----------	------	-------------------------------	----------	---------------	-----------------------	----------------	-----------------------	-------------------------	------------	-------------------------	-------------	---------------	----------	------------------	------------------	----------

Architecture System Selection Index

Colocation Campus and Building Infrastructure

Fiber Entrance, Meet-Me Room	High Fiber Count DC Interconnect	Campus Cabling	Building Cabling	IDF to Customer Cage (FACT ODF)	IDF to Customer Cage (19-in. Cabinet)	Campus Cabling for Wi-Fi and Security	MDA Fiber	EDA Fiber	EDA Copper	FiberGuide	MDA Cabinet	MDA Cross-connect 19-in.	MDA Cross-connect FACT ODF	IDF FACT	IDF 19-in.
------------------------------	----------------------------------	----------------	------------------	---------------------------------	---------------------------------------	---------------------------------------	-----------	-----------	------------	------------	-------------	--------------------------	----------------------------	----------	------------

Customer Space Cabling Infrastructure

Reference Designs and Technical Information



Review FACT Optical Distribution Frame (ODF) Modular Design here.

Frames	Dimensions	Max. Termination Capacity	Description Code	Part Number
Cross-connect frame, patching on the left	2200 mm x 1050 mm x 300 mm (87 in. x 41 in. x 12 in)	2688 single LC or 1344 SC connections per frame	760243094	FACT-FRCCCLHP22
Cross-connect frame, patching on the right	2200 mm x 1050 mm x 300 mm (87 in. x 41 in. x 12 in)	2688 single LC or 1344 SC connections per frame	760243095	FACT-FRCCRHP22
Interconnect frame, patching on the right	2200 mm x 900 mm x 300 mm (87 in. x 35 in. x 12 in)	2880 single LC or 1440 SC connections per frame	760243096	FACT-FRICRHP22
Path cord overlength management bay	2200 mm x 200 mm x 300 mm (87 in. x 8 in. x 12 in)	N/A	760243097	FACT-FROLB22
Frame Accessories			Description Code	Part Number
Cross-connect door kit. Set of two doors with two door handles per door. The door handles are compatible with half cylinder locks according to DIN 18252 (EN 1303). Locks not included.			760243098	FACT-FRCCD22
Cross-connect side panel kit (set of two panels)			760243099	FACT-FRCCP22
Interconnect door kit. Set of two doors with two door handles per door. The door handles are compatible with half cylinder locks according to DIN 18252 (EN 1303). Locks not included.			760243100	FACT-FRICD22
Patch cord overlength bay door. Set of one door with two door handles. The door handles are compatible with half cylinder locks according to DIN 18252 (EN 1303). Locks not included.			760243101	FACT-FROLBD22
Fiber guide fixation kit			760243110	FACT-FRACCFG5
Kit with two half cylinder locks according to DIN 18252 (EN 1303). Two lock kits are required for a frame door kit, only 1 lock kit required for OLB door kit.			760245341	FACT-FRACCDL2 (2-pack)
FACT Cable Attachment Plates	Compatible with Frame		Description Code	Part Number
One cable attachment plate for frame side duct and one cable to flex conversion component set	FACT		760243108	FACT-FRACCCAPL
One cable to flex conversion component set for cable attachment plate	FACT		760243111	FACT-FRACCCTF
One fan out fixation plate for frame side duct and eight fan out fixation component sets	FACT		760243109	FACT-FRACCFOPL
Eight fan out fixation component sets (for fan out fixation plate)	FACT		760243112	FACT-FRACCFOFK-8
FACT Cable Termination Units	Element Type		Description Code	Part Number
FACT cable termination unit (CTU), kit for 6E FACT chassis, accommodates: 1 cable 2.5-14 mm or 2 cables 2.5-8.5 mm or 4 cables 2.5-5 mm or 1 flex tube OD 16 mm, only for use in FACT frame	CTU		FACT-FRACCCTU6E	760243107
FACT cable termination unit (CTU), kit for 4E FACT chassis, accommodates: 1 cable 2.5-14 mm or 2 cables 2.5-8.5 mm or 4 cables 2.5-5 mm or 1 flex tube OD 16 mm, only for use in FACT frame	CTU		FACT-FRACCCTU4E	760243105
FACT cable termination unit (CTU), kit for 3E FACT chassis, accommodates: 1 cable 2.5-14 mm or 2 cables 2.5-8.5 mm or 4 cables 2.5-5 mm or 1 flex tube OD 16 mm, only for use in FACT frame	CTU		FACT-FRACCCTU3E	760243104
FACT cable termination unit (CTU), kit for 2E FACT chassis, accommodates: 1 cable 2.5-14 mm or 2 cables 2.5-8.5 mm or 4 cables 2.5-5 mm or 1 flex tube OD 16 mm, only for use in FACT frame	CTU		FACT-FRACCCTU2E	760243103
FACT cable termination unit (CTU), kit for 1E FACT chassis, accommodates: 1 cable 2.5-14 mm or 2 cables 2.5-8.5 mm or 4 cables 2.5-5 mm or 1 flex tube OD 16 mm, only for use in FACT frame	CTU		FACT-FRACCCTU1E	760243102

All frame kits include:

- Wall and back-to-back connection kit
- Side-to-side connection kit
- Earthing kit
- Adjustable feet
- Intuitive installation instructions
- Color label kit for spool identification and intuitive patch cord routing
- Required hardware and fasteners
- Pre-installed position number identification strip for FACT-style and 19-in.-style

All frame accessory kits include:

- Intuitive installation instruction
- Required hardware and fasteners

Direct System Selection Index

BUDI	FACT ODF	UMSC	Flex Frame ODF, 19-in. Propel	FOSC 600	19-in. Splice	Rollable Ribbon Fiber	Other Products	Pre-term 19-in. Fiber	Pre-term FACT ODF Fiber	FiberGuide	Cable Mgmt Wire Baskets	Category 6A	Powered Fiber	DIN Rail	Fiber Wall Boxes	2 Post Equipment	imVision
------	----------	------	-------------------------------	----------	---------------	-----------------------	----------------	-----------------------	-------------------------	------------	-------------------------	-------------	---------------	----------	------------------	------------------	----------

Architecture System Selection Index

Colocation Campus and Building Infrastructure

Fiber Entrance, Meet-Me Room	High Fiber Count DC Interconnect	Campus Cabling	Building Cabling	IDF to Customer Cage (FACT ODF)	IDF to Customer Cage (19-in. Cabinet)
------------------------------	----------------------------------	----------------	------------------	---------------------------------	---------------------------------------

Customer Space Cabling Infrastructure

Campus Cabling for Wi-Fi and Security	MDA Fiber	EDA Fiber	EDA Copper	FiberGuide
---------------------------------------	-----------	-----------	------------	------------

Reference Designs and Technical Information

MDA Cabinet	MDA Cross-connect 19-in.	MDA Cross-connect FACT ODF	IDF FACT	IDF 19-in.
-------------	--------------------------	----------------------------	----------	------------



Review FACT Optical Distribution Frame (ODF) Modular Design here.

FACT Splice-Patch and Splice-Splice Elements	Element Type	Fiber Count	Fiber Type/Splice Protection	Description Code	Part Number
FACT Fiber Optic Patch/Splice Panel, gray, 6E high, 288-port, singlemode, loaded with LC/UPC adapters and C-grade pigtails, SMOUV splice tray type, left-hand patch	Splice-Patch	288	OS2/SMOUV	FACT-6ELHPL1S	760240562
FACT Fiber Optic Patch/Splice Panel, gray, 6E high, 288-port, singlemode, loaded with LC/UPC adapters and C-grade pigtails, SMOUV splice tray type, right-hand patch	Splice-Patch	288	OS2/SMOUV	FACT-6ERHPL1S	760240694
FACT Fiber Optic Patch/Splice Panel, gray, 4E high, 192-port, singlemode, loaded with LC/UPC adapters and C-grade pigtails, SMOUV splice tray type, left-hand patch	Splice-Patch	192	OS2/SMOUV	FACT-4ELHPL1S	760240013
FACT Fiber Optic Patch/Splice Panel, gray, 4E high, 192-port, singlemode, loaded with LC/UPC adapters and C-grade pigtails, SMOUV splice tray type, right-hand patch	Splice-Patch	192	OS2/SMOUV	FACT-4ERHPL1S	760240055
FACT Fiber Optic Patch/Splice Panel, gray, 3E high, 144-port, singlemode, loaded with LC/UPC adapters and C-grade pigtails, SMOUV splice tray type, left-hand patch	Splice-Patch	144	OS2/SMOUV	FACT-3ELHPL1S	760240007
FACT Fiber Optic Patch/Splice Panel, gray, 3E high, 144-port, singlemode, loaded with LC/UPC adapters and C-grade pigtails, SMOUV splice tray type, right-hand patch	Splice-Patch	144	OS2/SMOUV	FACT-3ERHPL1S	760240027
FACT Fiber Optic Patch/Splice Panel, gray, 2E high, 96-port, singlemode, loaded with LC/UPC adapters and C-grade pigtails, SMOUV splice tray type, left-hand patch	Splice-Patch	96	OS2/SMOUV	FACT-2ELHPL1S	760240001
FACT Fiber Optic Patch/Splice Panel, gray, 2E high, 96-port, singlemode, loaded with LC/UPC adapters and C-grade pigtails, SMOUV splice tray type, right-hand patch	Splice-Patch	96	OS2/SMOUV	FACT-2ERHPL1S	760240020
FACT Fiber Optic Patch/Splice Panel, gray, 1E high, 48-port, singlemode, loaded with LC/UPC adapters and C-grade pigtails, SMOUV splice tray type, left-hand patch	Splice-Patch	48	OS2/SMOUV	FACT-1ELHPL1S	760240450
FACT Fiber Optic Patch/Splice Panel, gray, 1E high, 48-port, singlemode, loaded with LC/UPC adapters and C-grade pigtails, SMOUV splice tray type, right-hand patch	Splice-Patch	48	OS2/SMOUV	FACT-1ERHPL1S	760240585
FACT Splice Chassis	Number of Trays Per FACT Chassis				
The FACT splice chassis is a multipurpose splice shelf featuring up to 96 ANT splices or 72 SMOUV splices per FACT element. In combination with the FACT-ACCCTU accessories, the FACT splice chassis supports multiple splice applications, including: <ul style="list-style-type: none"> • Outdoor-to-indoor loose-tube cable • Loose-tube cable to pigtails (single aramid yarn termination) • Loose-tube cable to breakout or intra-facility (IFC) cable • Pigtail to pigtail (single aramid yarn termination) 		A04	S04	A12	S12
	1E	12	12	8	6
	2E	24	24	16	12
	3E	36	36	24	18
	4E	48	48	32	24
FACT Splice-Patch and Splice-Splice Elements	Element Type	Fiber Count	Fiber Type/Splice Protection	Description Code	Part Number
FACT Fiber Optic Splice Panel, gray, 4E high, loaded with 24 trays for holding up to 12 SMOUV type splices per tray	Splice - Splice	288	OS2 / SMOUV	FACT-4ESPLS12	760239970
FACT Fiber Optic Splice Panel, gray, 4E high, loaded with 18 trays for holding up to 12 SMOUV type splices per tray	Splice - Splice	216	OS2 / SMOUV	FACT-3ESPLS12	
FACT Fiber Optic Splice Panel, gray, 2E high, loaded with 12 trays for holding up to 12 SMOUV type splices per tray	Splice - Splice	144	OS2 / SMOUV	FACT-2ESPLS12	760239963
FACT Fiber Optic Splice Panel, gray, 1E high, loaded with 6 trays for holding up to 12 SMOUV type splices per tray	Splice - Splice	72	OS2 / SMOUV	FACT-1ESPLS12	760239959

- Use 250 um fiber when splicing into the FACT Splice/Patch Elements
- OSP Stranded Loose Tube 250 um fiber cables are suitable for the FACT Elements
- Stranded Loose Tube Rollable Ribbon type cables are also suitable for the FACT Elements

Note: FACT elements are also available with APC finish. See details [here](#).

Direct System Selection Index

BUDI	FACT ODF	UMSC	Flex Frame ODF, 19-in. Propel	FOSC 600	19-in. Splice	Rollable Ribbon Fiber	Other Products	Pre-term 19-in. Fiber	Pre-term FACT ODF Fiber	FiberGuide	Cable Mgmt Wire Baskets	Category 6A	Powered Fiber	DIN Rail	Fiber Wall Boxes	2 Post Equipment	imVision
------	----------	------	-------------------------------	----------	---------------	-----------------------	----------------	-----------------------	-------------------------	------------	-------------------------	-------------	---------------	----------	------------------	------------------	----------

Architecture System Selection Index

Colocation Campus and Building Infrastructure

Fiber Entrance, Meet-Me Room	High Fiber Count DC Interconnect	Campus Cabling	Building Cabling	IDF to Customer Cage (FACT ODF)	IDF to Customer Cage (19-in. Cabinet)	Campus Cabling for Wi-Fi and Security
------------------------------	----------------------------------	----------------	------------------	---------------------------------	---------------------------------------	---------------------------------------

Customer Space Cabling Infrastructure

MDA Fiber	EDA Fiber	EDA Copper	FiberGuide
-----------	-----------	------------	------------

Reference Designs and Technical Information

MDA Cabinet	MDA Cross-connect 19-in.	MDA Cross-connect FACT ODF	IDF FACT	IDF 19-in.
-------------	--------------------------	----------------------------	----------	------------



Review [FACT Optical Distribution Frame \(ODF\) Modular Design](#) here.

FACT Splice-Patch Chassis

Preterminated with pigtails

Enables splicing of OSP or ISP cables directly on the frame with no loss of density

Available with SC or LC preterminated connections

High-density chassis accommodates 24 SC or 48 single LC connections per FACT element

Uses the EIA/TIA 598 color-coding standard

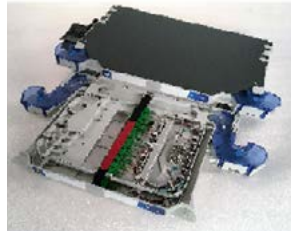

FACT — ¹XX ²X HP ³XX ⁴X

Element count	
1E	One element
2E	Two elements
3E	Three elements
4E	Four elements
5E	Five elements
6E	Six elements

Patch cord side	
L	Left-hand patch
R	Right-hand patch

Splice holder/protector (included)	
5	SMOUV
A	ANT

Adaptor/connector types, part count	
L1	LC UPC, C-grade, 48 single LC ports per element
L4	LC OM4, 48 single LC ports per element

FACT Splice Chassis

Multipurpose splice shelf

Features up to 96 ANT splices or 72 SMOUV splices per FACT element



Outdoor OSP Cable to Indoor Microsheath Cable



Indoor 250um Fiber Micro-sheath Cable

FACT — ¹XX SPL ²XXX

Element count	
1E	One element
2E	Two elements
3E	Three elements
4E	Four elements

Tray types	
A12	12 ANT splices
S12	12 SMOUV splices

Number of trays per FACT chassis		
	A12	S12
1E	8 = 96 splices	6 = 72 splices
2E	16 = 192 splices	12 = 144 splices
3E	24 = 288 splices	18 = 216 splices
4E	32 = 384 splices	24 = 288 splices

Direct System Selection Index

BUDI	FACT ODF	UMSC	Flex Frame ODF, 19-in. Propel	FOSC 600	19-in. Splice	Rollable Ribbon Fiber	Other Products	Pre-term 19-in. Fiber	Pre-term FACT ODF Fiber	FiberGuide	Cable Mgmt Wire Baskets	Category 6A	Powered Fiber	DIN Rail	Fiber Wall Boxes	2 Post Equipment	imVision
------	----------	------	-------------------------------	----------	---------------	-----------------------	----------------	-----------------------	-------------------------	------------	-------------------------	-------------	---------------	----------	------------------	------------------	----------

Architecture System Selection Index

Colocation Campus and Building Infrastructure

Fiber Entrance, Meet-Me Room	High Fiber Count DC Interconnect	Campus Cabling	Building Cabling	IDF to Customer Cage (FACT ODF)	IDF to Customer Cage (19-in. Cabinet)	Campus Cabling for Wi-Fi and Security	MDA Fiber	EDA Fiber	EDA Copper	FiberGuide	MDA Cabinet	MDA Cross-connect 19-in.	MDA Cross-connect FACT ODF	IDF FACT	IDF 19-in.
------------------------------	----------------------------------	----------------	------------------	---------------------------------	---------------------------------------	---------------------------------------	-----------	-----------	------------	------------	-------------	--------------------------	----------------------------	----------	------------

Customer Space Cabling Infrastructure

Reference Designs and Technical Information



Designed for flexibility and user friendliness, the Universal Mounted Splice Cabinet has the ability to mount in a 19-in. or 23-in. two- or four-post rack. It can also be mounted on the wall. This high density solution allows for up to 6912 splices in the 24-tray cabinet size, and 3456 splices in the 12-tray cabinet size, which are easily accessible due to the dedicated mesh tubing routing. The Universal Mounted Splice Cabinet's unique design includes over 6 ft (1.8 m) of slack to allow up to three splicers to be working side-by-side at the same time.



Direct System Selection Index

BUDI	FACT ODF	UMSC	Flex Frame ODF, 19-in. Propel	FOSC 600	19-in. Splice	Rollable Ribbon Fiber	Other Products	Pre-term 19-in. Fiber	Pre-term FACT ODF Fiber	FiberGuide	Cable Mgmt Wire Baskets	Category 6A	Powered Fiber	DIN Rail	Fiber Wall Boxes	2 Post Equipment	imVision
------	----------	------	-------------------------------	----------	---------------	-----------------------	----------------	-----------------------	-------------------------	------------	-------------------------	-------------	---------------	----------	------------------	------------------	----------

Architecture System Selection Index

Colocation Campus and Building Infrastructure

Fiber Entrance, Meet-Me Room	High Fiber Count DC Interconnect	Campus Cabling	Building Cabling	IDF to Customer Cage (FACT ODF)	IDF to Customer Cage (19-in. Cabinet)	Campus Cabling for Wi-Fi and Security	MDA Fiber	EDA Fiber	EDA Copper	FiberGuide	MDA Cabinet	MDA Cross-connect 19-in.	MDA Cross-connect FACT ODF	IDF FACT	IDF 19-in.
------------------------------	----------------------------------	----------------	------------------	---------------------------------	---------------------------------------	---------------------------------------	-----------	-----------	------------	------------	-------------	--------------------------	----------------------------	----------	------------

Customer Space Cabling Infrastructure

Reference Designs and Technical Information



Select a product for more information.



Splice Tray



SMOUV Splice Protectors



Meet-Me Room



Indoor or Indoor/
Outdoor Fiber Cable



Ribbon Cable Breakout Kit
(not required if using stranded indoor cable)

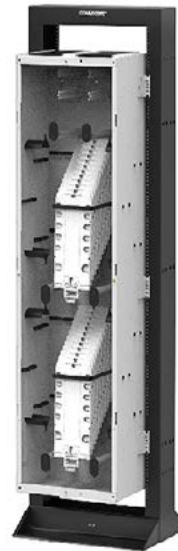

Universal Mount
Splice Cabinet



Outdoor Rollable
Ribbon Fiber Cable



Ribbon Cable Breakout Kit

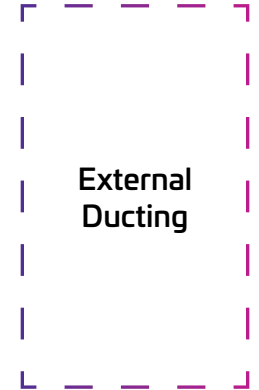

External
Ducting

Direct System Selection Index

BUDI	FACT ODF	UMSC	Flex Frame ODF, 19-in. Propel	FOSC 600	19-in. Splice	Rollable Ribbon Fiber	Other Products	Pre-term 19-in. Fiber	Pre-term FACT ODF Fiber	FiberGuide	Cable Mgmt Wire Baskets	Category 6A	Powered Fiber	DIN Rail	Fiber Wall Boxes	2 Post Equipment	imVision
------	----------	------	-------------------------------	----------	---------------	-----------------------	----------------	-----------------------	-------------------------	------------	-------------------------	-------------	---------------	----------	------------------	------------------	----------

Architecture System Selection Index

Colocation Campus and Building Infrastructure

Fiber Entrance, Meet-Me Room	High Fiber Count DC Interconnect	Campus Cabling	Building Cabling	IDF to Customer Cage (FACT ODF)	IDF to Customer Cage (19-in. Cabinet)	Campus Cabling for Wi-Fi and Security	MDA Fiber	EDA Fiber	EDA Copper	FiberGuide	MDA Cabinet	MDA Cross-connect 19-in.	MDA Cross-connect FACT ODF	IDF FACT	IDF 19-in.
------------------------------	----------------------------------	----------------	------------------	---------------------------------	---------------------------------------	---------------------------------------	-----------	-----------	------------	------------	-------------	--------------------------	----------------------------	----------	------------

Customer Space Cabling Infrastructure

Reference Designs and Technical Information



Review Universal Mount Splice Cabinet (UMSC) System Selection [here](#).

Universal Mount Splice Cabinet	Fiber Count	Dimensions	Weight	Description Code	Part Number
Universal Mount Splice Cabinet with up to 3456 fiber splices capacity (Rollable ribbon cables), 12 trays, exit up, gray	3,456	42.3 in. (1074 cm) x 17.84 in. (45.3 cm) x 11.54 in. (29.3 cm)	32 lbs. (14.5 kg)	ODF-SPLCAB-12	760248104
Universal Mount Splice Cabinet with up to 6912 fiber splices capacity (Rollable ribbon cables), 24 trays, exit up, gray	6,912	68.5 in. (174 cm) x 17.84 in. (45.3 cm) x 11.54 in. (29.3 cm)	52 lbs. (23.6 kg)	ODF-SPLCAB-24	760245548
Splicing Accessories	Fiber Count	Breakout Length	Description Code	Part Number	
FOST splice tray, 288f Rollable ribbon fiber splicing per tray	288	N/A	FOST-ACC-D-TRAY-RR-288-KIT	760243050	
Breakout kit used across multiple applications (BUDI, FLEX, OMX, SD cable counts 144F, 288F, 432F, 576F)	144/288/432/576	50 in	RIBCBOU-3/8-50-144/288/432/576	760244150	
Breakout kit used across multiple applications (BUDI, FLEX, SD)	864/1152	50 in	RIBCBOU-3/8-50-864/1152	760244144	
Breakout kit used across multiple applications (BUDI, FLEX, SD)	1728	75 in	RIBCBOU-3/8-75-1728	760244149	
Breakout kit used across multiple applications (BUDI, FLEX)	3456	125 in	RIBCBOU-3/8-125-3456	760244147	
Accessories			Description Code	Part Number	
Equipment Rack, 2-Post, 6 in. (152 mm) Channel x 7 ft (2134 mm) H - 19 in. (482.6 mm) Alu (45U) 12-24 Tapped Rails, Black		45U	RK6-45A	760082495	
19-in. rack mount brack for Universal Mount Splice Cabinet, 1 kit per cabinet			ODF-ACC-BRK-19	760245549	
Raised Floor Mounting Kit, 5/8-in.				FDF-ACC146	
SMOUV Fiber Optic Splice Heat Shrink Protective Sleeve for 12 ribbons (1000 sleeves per MID)	12 Ribbon Fibers per Sleeve		SMOUV-1120-R2/12-02	757849-000	
ODF-ACC-BRK-WM, Wall Mount brack for Universal Mount Splice Cabinet, 1 kit per cabinet			ODF-ACC-BRK-WM	760245551	
Concrete Floor Mounting Kit, 5/8-in.				RINST-FLR	

Direct System Selection Index

BUDI	FACT ODF	UMSC	Flex Frame ODF, 19-in. Propel	FOSC 600	19-in. Splice	Rollable Ribbon Fiber	Other Products	Pre-term 19-in. Fiber	Pre-term FACT ODF Fiber	FiberGuide	Cable Mgmt Wire Baskets	Category 6A	Powered Fiber	DIN Rail	Fiber Wall Boxes	2 Post Equipment	imVision
------	----------	------	-------------------------------	----------	---------------	-----------------------	----------------	-----------------------	-------------------------	------------	-------------------------	-------------	---------------	----------	------------------	------------------	----------

Architecture System Selection Index

Colocation Campus and Building Infrastructure

Fiber Entrance, Meet-Me Room	High Fiber Count DC Interconnect	Campus Cabling	Building Cabling	IDF to Customer Cage (FACT ODF)	IDF to Customer Cage (19-in. Cabinet)	Campus Cabling for Wi-Fi and Security	MDA Fiber	EDA Fiber	EDA Copper	FiberGuide	MDA Cabinet	MDA Cross-connect 19-in.	MDA Cross-connect FACT ODF	IDF FACT	IDF 19-in.
------------------------------	----------------------------------	----------------	------------------	---------------------------------	---------------------------------------	---------------------------------------	-----------	-----------	------------	------------	-------------	--------------------------	----------------------------	----------	------------

Customer Space Cabling Infrastructure

Reference Designs and Technical Information



- Accepts up to nine 4RU chassis
- Enables interconnect and/or cross-connect applications
- Integral slack storage reduces jumper congestion
- An integrated lower trough system with passthrough simplifies cable routing in a frame lineup
- On-frame splicing eliminates the need to access the rear of each panel to perform splicing, thereby reducing the risk of damage to the panel's internal components
- Integrated left-side cable entry ports on splice cabinet standardizes the length of split convoluted tubing needed to provide additional protection of the mesh sleeve-enclosed 24-fiber ribbon bundles
- Slack storage capacity of at least 10 ft (3.05 m) of mesh-enclosed ribbon slack per 24-fiber ribbon bundle
- An optional locking door to provide protection against unauthorized access to the entire frame

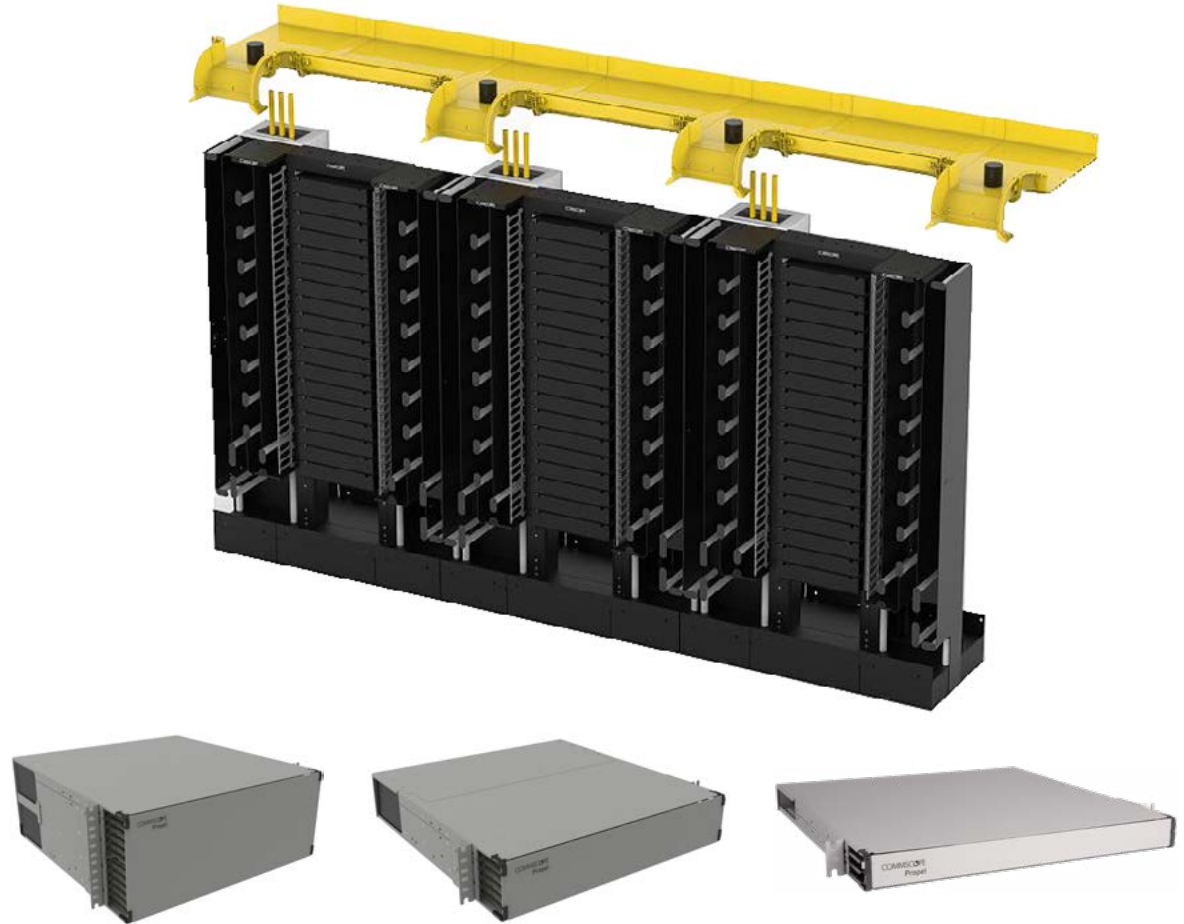

Propel fiber solutions are designed for today's more crowded and demanding environments. Propel supports 72 duplex LC ports or 72 MPO ports per RU.

Direct System Selection Index

BUDI	FACT ODF	UMSC	Flex Frame ODF, 19-in. Propel	FOSC 600	19-in. Splice	Rollable Ribbon Fiber	Other Products	Pre-term 19-in. Fiber	Pre-term FACT ODF Fiber	FiberGuide	Cable Mgmt Wire Baskets	Category 6A	Powered Fiber	DIN Rail	Fiber Wall Boxes	2 Post Equipment	imVision
------	----------	------	-------------------------------	----------	---------------	-----------------------	----------------	-----------------------	-------------------------	------------	-------------------------	-------------	---------------	----------	------------------	------------------	----------

Architecture System Selection Index

Colocation Campus and Building Infrastructure

Fiber Entrance, Meet-Me Room	High Fiber Count DC Interconnect	Campus Cabling	Building Cabling	IDF to Customer Cage (FACT ODF)	IDF to Customer Cage (19-in. Cabinet)	Campus Cabling for Wi-Fi and Security	MDA Fiber	EDA Fiber	EDA Copper	FiberGuide	MDA Cabinet	MDA Cross-connect 19-in.	MDA Cross-connect FACT ODF	IDF FACT	IDF 19-in.
------------------------------	----------------------------------	----------------	------------------	---------------------------------	---------------------------------------	---------------------------------------	-----------	-----------	------------	------------	-------------	--------------------------	----------------------------	----------	------------

Customer Space Cabling Infrastructure

Reference Designs and Technical Information



Select a product for more information.

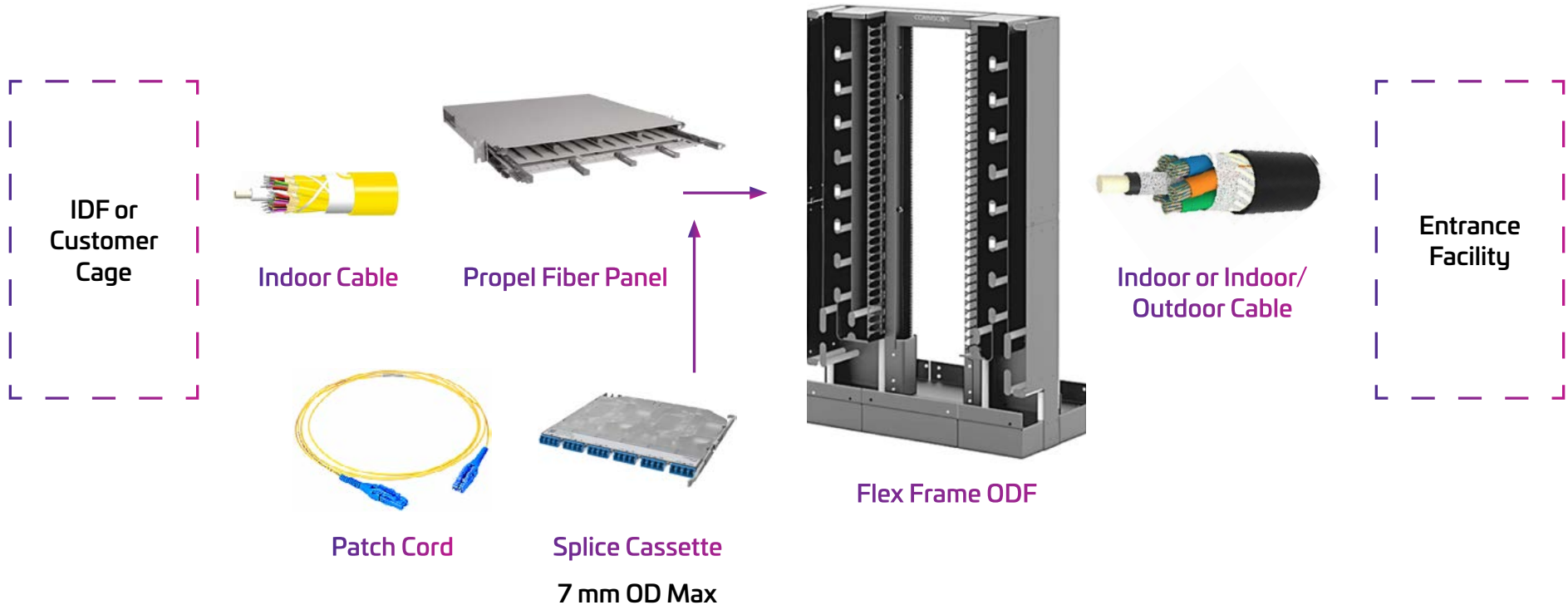

Direct System Selection Index

BUDI	FACT ODF	UMSC	Flex Frame ODF, 19-in. Propel	FOSC 600	19-in. Splice	Rollable Ribbon Fiber	Other Products	Pre-term 19-in. Fiber	Pre-term FACT ODF Fiber	FiberGuide	Cable Mgmt Wire Baskets	Category 6A	Powered Fiber	DIN Rail	Fiber Wall Boxes	2 Post Equipment	imVision
------	----------	------	-------------------------------	----------	---------------	-----------------------	----------------	-----------------------	-------------------------	------------	-------------------------	-------------	---------------	----------	------------------	------------------	----------

Architecture System Selection Index

Colocation Campus and Building Infrastructure

Fiber Entrance, Meet-Me Room	High Fiber Count DC Interconnect	Campus Cabling	Building Cabling	IDF to Customer Cage (FACT ODF)	IDF to Customer Cage (19-in. Cabinet)	Campus Cabling for Wi-Fi and Security	MDA Fiber	EDA Fiber	EDA Copper	FiberGuide	MDA Cabinet	MDA Cross-connect 19-in.	MDA Cross-connect FACT ODF	IDF FACT	IDF 19-in.
------------------------------	----------------------------------	----------------	------------------	---------------------------------	---------------------------------------	---------------------------------------	-----------	-----------	------------	------------	-------------	--------------------------	----------------------------	----------	------------

Customer Space Cabling Infrastructure

Reference Designs and Technical Information



Review Flex Frame ODF System Selection here.

Flex Frame ODF	Dimensions		Weight	Description Code	Part Number
Rack with cable managers, 19" standard mouting, 36ru of open rack space	H: 2133.6 mm 84 in W: 1339.09 mm 52.72 in D: 1339.09 mm 52.72 in		181.437 kg 400 kg	ODF-FF19CM-36	760242401
Propel Chassis	HU	Max Number of LC Connectors	Number of 12 Fiber Propel Splice Cassettes	Description Code	Part Number
Propel 4RU sliding tray fiber panel, accepts Propel ULL modules or adapter packs, providing up to 288 duplex LC ports, 288 MPO ports or 576 SN ports (1152f)	4	576	48	PPL-4U	760252004
Propel 2RU sliding tray fiber panel, accepts Propel ULL modules or adapter packs, providing up to 144 duplex LC ports, 144 MPO ports or 288 SN ports (576f)	2	288	24	PPL-2U	760252003
Propel 1RU sliding tray fiber panel, accepts Propel ULL modules or adapter packs, providing up to 72 duplex LC ports, 72 MPO ports or 144 SN ports (288f)	1	144	12	PPL-1U	760252002
Splice Cassettes	Fiber Type	Pigtail Fiber Type	Polarity Method	Description Code	Part Number
Propel Singlemode Splice Cassette, 24LC/UPC with internal shutters, OS2 ribbon fiber pigtail, Method B Enhanced ULL	OS2	Rollable Ribbon	Method B Enhanced	PPL-SP-24LC-SM-RPT-BEU	760255056
Propel Singlemode Splice Cassette, 24LC/UPC with internal shutters, OS2 250µm single fiber pigtails, Method B Enhanced ULL	OS2	Stranded	Mehtod B Enhanced	PPL-SP-24LC-SM-PT-BEU	760255053
Propel Singlemode Splice Cassette, 24LC/UPC with internal shutters, OS2 250µm single fiber pigtails, Method A Straight ULL	OS2	Stranded	Method A (Pairs Straight)	PPL-SP-24LC-SM-PT-ASU	760255081
Propel Multimode Splice Cassette, 24LC/UPC with internal shutters, OM4 250µm single fiber pigtails, Method B Enhanced ULL	OM4	Stranded	Method B Enhanced	PPL-SP-24LC-OM4-PT-BEU	760255054
Propel Multimode Splice Cassette, 24LC/UPC with internal shutters, OM4 ribbon fiber pigtail, Method B Enhanced ULL	OM4	Rollable Ribbon	Mehtod B Enhanced	PPL-SP-24LC-OM4-RPT-BEU	760255057
Accessories				Description Code	Part Number
Raised Floor Mounting Kit, 5/8-in				N/A	FDF-ACC146
Concrete Floor Mounting Kit, 5/8-in				N/A	RINST-FLR
Small universal blocking kit, for use with ribbon fiber splice cassettes				BK-FP-SML	760238380

Direct System Selection Index

BUDI	FACT ODF	UMSC	Flex Frame ODF, 19-in. Propel	FOSC 600	19-in. Splice	Rollable Ribbon Fiber	Other Products	Pre-term 19-in. Fiber	Pre-term FACT ODF Fiber	FiberGuide	Cable Mgmt Wire Baskets	Category 6A	Powered Fiber	DIN Rail	Fiber Wall Boxes	2 Post Equipment	imVision
------	----------	------	-------------------------------	----------	---------------	-----------------------	----------------	-----------------------	-------------------------	------------	-------------------------	-------------	---------------	----------	------------------	------------------	----------

Architecture System Selection Index

Colocation Campus and Building Infrastructure						Customer Space Cabling Infrastructure					Reference Designs and Technical Information						
Fiber Entrance, Meet-Me Room	High Fiber Count DC Interconnect	Campus Cabling	Building Cabling	IDF to Customer Cage (FACT ODF)	IDF to Customer Cage (19-in. Cabinet)	Campus Cabling for Wi-Fi and Security	MDA Fiber	EDA Fiber	EDA Copper	FiberGuide	MDA Cabinet	MDA Cross-connect 19-in.	MDA Cross-connect FACT ODF	IDF FACT	IDF 19-in.		



With the FOSC 600 Series, CommScope offers customers high-capacity fiber splicing solutions built on the industry-leading design of the FOSC series and our unique engineering expertise in delivering both high density and ease of use.

The FOSC 600 Series can be used in a variety of trunk and feeder applications for splicing a wide range of fiber cable types and sizes, housing of connectorized distribution and demarcation points and deployment of optical passives.

The sealing system of the FOSC 600 builds on the proven reliability of the FOSC 450 series and features the versatile and popular gel sealing technology for termination cables and a unique latching system for quick closure opening and closing without any special tools required.

The FOSC 600D Series can be deployed anywhere in the outside plant for a multitude of functions including the splicing of almost any cable type, up to 1.4 in.(3.56 cm) diameter and 1,728 fiber splice capacity. It's used to house the connectorized distribution and demarcation points and the deployment of optical passives.

Using the same closure, the FOSC 600D-XL series is like the 600D except it has a larger tray tower

enabling up to 12 single fiber trays or six ribbon fiber trays with up to 3,456 fiber splice capacity.

Features and benefits

- Up to 1,728 single fibers or 3,456 ribbon fibers
- Up to 12 single fiber trays or six ribbon fiber trays
- Up to 16 separate cable ports
- Cables up to 1.4 in.(3.56 cm) diameter
- Compact size designed for easy field stacking
- Butt or inline splice closure, field configurable
- All internal parts can be removed for easy re-configuration
- Hinging trays with controlled access to splices and slack storage
- Superior fiber management
- Storage basket included
- Wall-mount bracket included

- Slack ribbon storage on the same tray as mass fusion splices
- A range of accessories for a variety of outside plant needs



Learn about dressing ribbon fiber into FOSC and splice tray here.



Shown with 12 single height trays

Direct System Selection Index

BUDI	FACT ODF	UMSC	Flex Frame ODF, 19-in. Propel	FOSC 600	19-in. Splice	Rollable Ribbon Fiber	Other Products	Pre-term 19-in. Fiber	Pre-term FACT ODF Fiber	FiberGuide	Cable Mgmt Wire Baskets	Category 6A	Powered Fiber	DIN Rail	Fiber Wall Boxes	2 Post Equipment	imVision
------	----------	------	-------------------------------	----------	---------------	-----------------------	----------------	-----------------------	-------------------------	------------	-------------------------	-------------	---------------	----------	------------------	------------------	----------

Architecture System Selection Index

Colocation Campus and Building Infrastructure							Customer Space Cabling Infrastructure					Reference Designs and Technical Information					
Fiber Entrance, Meet-Me Room	High Fiber Count DC Interconnect	Campus Cabling	Building Cabling	IDF to Customer Cage (FACT ODF)	IDF to Customer Cage (19-in. Cabinet)	Campus Cabling for Wi-Fi and Security	MDA Fiber	EDA Fiber	EDA Copper	FiberGuide	MDA Cabinet	MDA Cross-connect 19-in.	MDA Cross-connect FACT ODF	IDF FACT	IDF 19-in.		



Select a product for more information.



Rollable Ribbon Fiber Cable



FOSC Fiber Splice Closure



Rollable Ribbon Fiber Cable



FOSC600D-XL Fiber Splice Closure with Splice Trays	Dimensions	Total Number of Splices	Number of Splice Trays Included	Number of Splices Per Tray	Description Code	Part Number
3,456 fiber splice capacity. FOSC 600D-XL Fiber Optic Splice Closure Kit with 12 x FOSC D-48 standard size splice trays installed, each capable of up to 288 splices of 12 fiber “rollable ribbon” or “spider ribbon” fiber. Kit also includes 2 x 3-port FOSC 600 gel blocks, XL version slack storage basket, 2 x ground feedthrough lugs, flash test valve, and associated closure hardware and components.	10 in. (25.4 cm) x 10.8 in. (27.4 cm) x 32.6 in. (82.8 cm)	3,456	12	288	FOSC600-D6B-24-12-X2VXL	379484-000
1,728 fiber splice capacity. FOSC 600D-XL Fiber Optic Splice Closure Kit with 6 x FOSC D size Ribbon splice trays installed, each capable of up to 288 splices of ribbon 12 fiber. Kit also includes 2 x 3-port FOSC 600 gel blocks, XL version slack storage basket, 2 x ground feedthrough lugs, flash test valve, and associated closure hardware and components.	10 in. (25.4 cm) x 10.8 in. (27.4 cm) x 32.6 in. (82.8 cm)	1,728	6	288	FOSC600-D6B-R2-6-X2VXL	233947-000
864 fiber splice capacity. FOSC 600D-XL Fiber Optic Splice Closure Kit with 6 x FOSC D size Ribbon splice trays installed, each capable of up to 288 splices of ribbon 12 fiber. Kit also includes 2 x 4-port FOSC 600 gel blocks, XL version slack storage basket, 2 x ground feedthrough lugs, flash test valve, and associated closure hardware and components.	10 in. (25.4 cm) x 10.8 in. (27.4 cm) x 32.6 in. (82.8 cm)	864	6	288	FOSC600-D8B-R2-6-X2VXL	371599-000

CommScope offers a range of fiber splice enclosures to manage 160+ fibers. Please contact your partner or CommScope TAC for more details.

Direct System Selection Index

BUDI	FACT ODF	UMSC	Flex Frame ODF, 19-in. Propel	FOSC 600	19-in. Splice	Rollable Ribbon Fiber	Other Products	Pre-term 19-in. Fiber	Pre-term FACT ODF Fiber	FiberGuide	Cable Mgmt Wire Baskets	Category 6A	Powered Fiber	DIN Rail	Fiber Wall Boxes	2 Post Equipment	imVision
------	----------	------	-------------------------------	----------	---------------	-----------------------	----------------	-----------------------	-------------------------	------------	-------------------------	-------------	---------------	----------	------------------	------------------	----------

Architecture System Selection Index

Colocation Campus and Building Infrastructure

Fiber Entrance, Meet-Me Room	High Fiber Count DC Interconnect	Campus Cabling	Building Cabling	IDF to Customer Cage (FACT ODF)	IDF to Customer Cage (19-in. Cabinet)	Campus Cabling for Wi-Fi and Security	MDA Fiber	EDA Fiber	EDA Copper	FiberGuide	MDA Cabinet	MDA Cross-connect 19-in.	MDA Cross-connect FACT ODF	IDF FACT	IDF 19-in.
------------------------------	----------------------------------	----------------	------------------	---------------------------------	---------------------------------------	---------------------------------------	-----------	-----------	------------	------------	-------------	--------------------------	----------------------------	----------	------------

Customer Space Cabling Infrastructure

Reference Designs and Technical Information



Select a product for more information.

EPX
48 ports LC-D or 32 ports MPO
Basic labeling

Cable Attachment Kit



Cable Attachment Kit



Fiber Cable
9 mm OD max

G2 Splice Module
9.0 mm OD max



G2 Splice Module
9.0 mm OD max

EPX Panel
9.0 mm OD max



EPX Panel
9.0 mm OD max

Patch Cord



Patch Cord

Propel
72 ports LC-D or 72 ports MPO
Front cable management
Labeling option (printer support)
Sliding tray for better cable modules access

Propel Splice Module
6.5 mm OD max

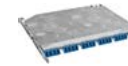

Propel Splice Module
6.5 mm OD max

Propel Panel

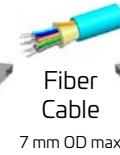

Fiber Cable
7 mm OD max



Propel Panel

Patch Cord



Patch Cord

HD
48 ports LC-D or 32 ports MPO
Front cable management
Labeling option (printer support)
Sliding tray for easier cable/modules access

G2 Splice Module



G2 Splice Module



Fiber Cable
9 mm OD max

HD Panel



HD Panel

Patch Cord



Patch Cord

FMS Termination and Splice Panel
1U
Total of 12, 24 or 48 fibers per panel
Available in LC and SC preloaded with pigtailed
Front panel access

FMS Panel



FMS Panel

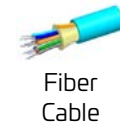

Fiber Cable

Patch Cord



Patch Cord

Direct System Selection Index

BUDI	FACT ODF	UMSC	Flex Frame ODF, 19-in. Propel	FOSC 600	19-in. Splice	Rollable Ribbon Fiber	Other Products	Pre-term 19-in. Fiber	Pre-term FACT ODF Fiber	FiberGuide	Cable Mgmt Wire Baskets	Category 6A	Powered Fiber	DIN Rail	Fiber Wall Boxes	2 Post Equipment	imVision
------	----------	------	-------------------------------	----------	---------------	-----------------------	----------------	-----------------------	-------------------------	------------	-------------------------	-------------	---------------	----------	------------------	------------------	----------

Architecture System Selection Index

Colocation Campus and Building Infrastructure

Fiber Entrance, Meet-Me Room	High Fiber Count DC Interconnect	Campus Cabling	Building Cabling	IDF to Customer Cage (FACT ODF)	IDF to Customer Cage (19-in. Cabinet)	Campus Cabling for Wi-Fi and Security	MDA Fiber	EDA Fiber	EDA Copper	FiberGuide	MDA Cabinet	MDA Cross-connect 19-in.	MDA Cross-connect FACT ODF	IDF FACT	IDF 19-in.
------------------------------	----------------------------------	----------------	------------------	---------------------------------	---------------------------------------	---------------------------------------	-----------	-----------	------------	------------	-------------	--------------------------	----------------------------	----------	------------

Customer Space Cabling Infrastructure

Reference Designs and Technical Information



Review 19-in. Splice Solutions System Selection here.

EPX
HD
Propel

Fits to					Description Code	Part Number			
	EPX Panels	EPX 1U sliding panel, accepts (4) G2 style splice cassettes, modules or adapter packs, providing up to 48 duplex LC ports			EPX-1U-MOD-ENC	760249998			
		EPX 3U Splicing Fiber Panel accepts up to 7 AGL splice trays providing up to 336 single fiber splicing or up to 1008 ribbon fiber splicing			EPX-3U-SPL-ENC	760254513			
Fits to		Splice Accessories			Description Code	Part Number			
		Cable Attachment Kit for EPX fiber panel				1671273-1			
		Fiber optic splice tray, stackable, for SMOUV splice protectors, 48 splices per tray, SMOUVs and SMOUV holder included			AGL-SPLICE-48	760241378			
		Ribbon Fiber Splice Tray Kit, stackable, 12 ribbon capacity			AGL-SPLICE-48	760243494			
Fits to		Splice Modules/Adapter Packs	Fiber	Module	Description Code	Part Number			
		G2 Distribution Adapter Pack 12 LC with internal shutters, Multimode OM4 Aqua	OM4	Adapter Pack	360DPis-24LC-LS	760216754			
		G2 Distribution Adapter Pack 24 LC with internal shutters, Multimode OM5 Lime Green	OM5	Adapter Pack	360DPis-24LC-WB	760236041			
		G2 Distribution Adapter Pack 12 LC with internal shutters, Singlemode Blue	OS2	Adapter Pack	360DPis-24LC-SM	760216762			
Fits to		High Density Panels			RU	Description Code	Part Number		
		High Density 1U modular cassette sliding Panel, accepts (4) InstaPATCH® 360 modules or MPO panels, providing up to 48 duplex LC ports, or up to 32 MPO ports			1	HD-1U	760209940		
		High Density 2U modular cassette sliding Panel, accepts (8) InstaPATCH 360 modules or MPO panels, providing up to 96 duplex LC ports or up to 64 MPO ports			2	HD-2U	760209957		
Fits to		Splice Modules/Accessories			Fiber	Module	Description Code	Part Number	
		G2 Splice Cassette 24 LC, OM4, including pigtails	OM4	G2	G2-SP-24LCX-PT	760244927			
		G2 Splice Cassette 24 LC, OS2, including pigtails	OS2	G2	G2-SP-24LCG-PT	760244929			
		G2 blank adapters, 4 pcs	N/A	N/A	360G2-MOD-BLANK-4PK	760109462			
		G2 footprint accessories label kit			G2 FLEX LABEL KIT (12pcs)	760245472			
		Vertical Cable Guide Kit			VERT-CBL-BKT	760237133			
Fits to		Propel Chassis			HU	Description Code	Part Number		
		Propel 4RU sliding tray fiber panel, accepts Propel ULL modules or adapter packs, providing up to 288 duplex LC ports, 288 MPO ports or 576 SN ports (1152f)			4	PPL-4U	760252004		
		Propel Singlemode Splice Cassette, 24LC/UPC with internal shutters, OS2 ribbon fiber pigtail, Method B Enhanced ULL			2	PPL-2U	760252003		
		Propel Singlemode Splice Cassette, 24LC/UPC with internal shutters, OS2 250µm single fiber pigtails, Method B Enhanced ULL			1	PPL-1U	760252002		
Fits to		Splice Cassettes			Fiber	Type	Polarity Method	Description Code	Part Number
		Propel Singlemode Splice Cassette, 24LC/UPC with internal shutters, OS2 ribbon fiber pigtail, Method B Enhanced ULL			OS2	Rollable Ribbon	Method B Enhanced	PPL-SP-24LC-SM-RPT-BEU	760255056
		Propel Singlemode Splice Cassette, 24LC/UPC with internal shutters, OS2 250µm single fiber pigtails, Method B Enhanced ULL			OS2	Stranded	Method B Enhanced	PPL-SP-24LC-SM-PT-BEU	760255053
		Propel Singlemode Splice Cassette, 24LC/UPC with internal shutters, OS2 250µm single fiber pigtails, Method A Straight ULL			OS2	Stranded	Method A Pairs Straight	PPL-SP-24LC-SM-PT-ASU	760255081
		Propel Multimode Splice Cassette, 24LC/UPC with internal shutters, OM4 250µm single fiber pigtails, Method B Enhanced ULL			OM4	Stranded	Method B Enhanced	PPL-SP-24LC-OM4-PT-BEU	760255054
		Propel Multimode Splice Cassette, 24LC/UPC with internal shutters, OM4 ribbon fiber pigtail, Method B Enhanced ULL			OM4	Rollable Ribbon	Method B Enhanced	PPL-SP-24LC-OM4-RPT-BEU	760255057
Fits to		19-in. Cable Management Accessories			Type	Description Code		Part Number	
		Large universal blocking kit. Used for on-frame blocking and breakout of Rollable Ribon cables into 19-in. Panels			Rollable Ribbon	BK-FP-LRG		760238381	
		Small universal blocking kit. Used for on-frame blocking and breakout of Rollable Ribon cables into 19-in. Panels			Rollable Ribbon	BK-FP-SML		760238380	

Direct System Selection Index

BUDI	FACT ODF	UMSC	Flex Frame ODF, 19-in. Propel	FOSC 600	19-in. Splice	Rollable Ribbon Fiber	Other Products	Pre-term 19-in. Fiber	Pre-term FACT ODF Fiber	FiberGuide	Cable Mgmt Wire Baskets	Category 6A	Powered Fiber	DIN Rail	Fiber Wall Boxes	2 Post Equipment	imVision
------	----------	------	-------------------------------	----------	---------------	-----------------------	----------------	-----------------------	-------------------------	------------	-------------------------	-------------	---------------	----------	------------------	------------------	----------

Architecture System Selection Index

Colocation Campus and Building Infrastructure

Fiber Entrance, Meet-Me Room	High Fiber Count DC Interconnect	Campus Cabling	Building Cabling	IDF to Customer Cage (FACT ODF)	IDF to Customer Cage (19-in. Cabinet)	Campus Cabling for Wi-Fi and Security	MDA Fiber	EDA Fiber	EDA Copper	FiberGuide	MDA Cabinet	MDA Cross-connect 19-in.	MDA Cross-connect FACT ODF	IDF FACT	IDF 19-in.
------------------------------	----------------------------------	----------------	------------------	---------------------------------	---------------------------------------	---------------------------------------	-----------	-----------	------------	------------	-------------	--------------------------	----------------------------	----------	------------

Customer Space Cabling Infrastructure

Reference Designs and Technical Information



CommScope has made enhancements to the design of the 1RU FMS termination and splice panels for APAC enterprise market. The new 1U FMS panel is preloaded with adaptors, 12-color pigtail kits, splice trays, splice protectors and other accessories in the factory. The packaging is also sturdier for international shipping.

Enhanced FMS Fiber Panels	Description Code	Part Number
FMS Panel, 1U, 19 in, black, Includes 6 x SC SM Duplex Adaptors (12F), 12 x SM SC Pigtails, 12 x Splice protectors. Splice tray and cable glands	FMS-K1BI-S1A1-12-SP	760254122
FMS Panel, 1U, 19 in, black, Includes 12 x SC SM Duplex Adaptors (24F), 24 x SM SC Pigtails, 24 x Splice protectors. Splice tray and cable glands	FMS-K2BI-S1A1-24-SP	760254435
FMS Panel, 1U, 19 in, black, Includes 6 x LC SM Duplex Adaptors (12F), 12 x SM LC Pigtails, 12 x Splice protectors. Splice tray and cable glands	FMS-K1BI-L1A1-12-SP	760254436
FMS Panel, 1U, 19 in, black, Includes 12 x LC SM Duplex Adaptors (24F), 24 x SM LC Pigtails, 24 x Splice protectors. Splice trays (2) and cable glands	FMS-K2BI-L1A1-24-SP	760254437
FMS Panel, 1U, 19 in, black, Includes 24 x LC SM Duplex Adaptors (48F), 48 x SM LC Pigtails, 48 x Splice protectors. Splice trays (2) and cable glands	FMS-K2BI-L1A1-48-SP	760254438
FMS Panel, 1U, 19 in, black, Includes 6 x SC OM4 Duplex Adaptors (12F), 12 x OM4 SC Pigtails, 12 x Splice protectors. Splice tray and cable glands	FMS-K1BI-SOM4-12-SP	760254439
FMS Panel, 1U, 19 in, black, Includes 12 x SC OM4 Duplex Adaptors (24F), 24 x OM4 SC Pigtails, 24 x Splice protectors. Splice tray and cable glands	FMS-K2BI-SOM4-24-SP	760254440
FMS Panel, 1U, 19 in, black, Includes 6 x LC OM4 Duplex Adaptors (12F), 12 x OM4 LC Pigtails, 12 x Splice protectors. Splice tray and cable glands	FMS-K1BI-LOM4-12-SP	760254441
FMS Panel, 1U, 19 in, black, Includes 12 x LC OM4 Duplex Adaptors (24F), 24 x OM4 LC Pigtails, 24 x Splice protectors. Splice trays (2) and cable glands	FMS-K2BI-LOM4-24-SP	760254442
FMS Panel, 1U, 19 in, black, Includes 24 x LC OM4 Duplex Adaptors (48F), 48 x OM4 LC Pigtails 48 x Splice protectors. Splice trays (2) and cable glands	FMS-K2BI-LOM4-48-SP	760254443



Direct System Selection Index

BUDI	FACT ODF	UMSC	Flex Frame ODF, 19-in. Propel	FOSC 600	19-in. Splice	Rollable Ribbon Fiber	Other Products	Pre-term 19-in. Fiber	Pre-term FACT ODF Fiber	FiberGuide	Cable Mgmt Wire Baskets	Category 6A	Powered Fiber	DIN Rail	Fiber Wall Boxes	2 Post Equipment	imVision
------	----------	------	-------------------------------	----------	---------------	-----------------------	----------------	-----------------------	-------------------------	------------	-------------------------	-------------	---------------	----------	------------------	------------------	----------

Architecture System Selection Index

Colocation Campus and Building Infrastructure

Fiber Entrance, Meet-Me Room	High Fiber Count DC Interconnect	Campus Cabling	Building Cabling	IDF to Customer Cage (FACT ODF)	IDF to Customer Cage (19-in. Cabinet)	Campus Cabling for Wi-Fi and Security	MDA Fiber	EDA Fiber	EDA Copper	FiberGuide	MDA Cabinet	MDA Cross-connect 19-in.	MDA Cross-connect FACT ODF	IDF FACT	IDF 19-in.
------------------------------	----------------------------------	----------------	------------------	---------------------------------	---------------------------------------	---------------------------------------	-----------	-----------	------------	------------	-------------	--------------------------	----------------------------	----------	------------

Customer Space Cabling Infrastructure

Reference Designs and Technical Information



Select a product for more information.

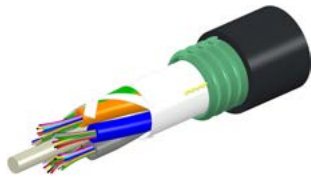

Outdoor Armored Cable



Indoor Stranded Microsheath Cable



Indoor Rollable Ribbon Central Loose Tube Cable



Indoor Rollable Ribbon Loose Tube Cable



Indoor/Outdoor Rollable Ribbon Central Tube Cable, Interlocking Armored



Indoor/Outdoor Rollable Ribbon Loose Tube Cable, Interlocking Armored



Indoor/Outdoor Rollable Ribbon Central Loose Tube Cable



Indoor/Outdoor Rollable Ribbon Loose Tube Cable



Outdoor Rollable Ribbon Stranded Loose Tube Cable, Armored



Outdoor Rollable Ribbon Stranded Loose Tube Cable

Learn more about CommScope's [Rollable Ribbon Fiber Solutions here.](#)

Direct System Selection Index

BUDI	FACT ODF	UMSC	Flex Frame ODF, 19-in. Propel	FOSC 600	19-in. Splice	Rollable Ribbon Fiber	Other Products	Pre-term 19-in. Fiber	Pre-term FACT ODF Fiber	FiberGuide	Cable Mgmt Wire Baskets	Category 6A	Powered Fiber	DIN Rail	Fiber Wall Boxes	2 Post Equipment	imVision
------	----------	------	-------------------------------	----------	---------------	-----------------------	----------------	-----------------------	-------------------------	------------	-------------------------	-------------	---------------	----------	------------------	------------------	----------

Architecture System Selection Index

Colocation Campus and Building Infrastructure

Fiber Entrance, Meet-Me Room	High Fiber Count DC Interconnect	Campus Cabling	Building Cabling	IDF to Customer Cage (FACT ODF)	IDF to Customer Cage (19-in. Cabinet)	Campus Cabling for Wi-Fi and Security
------------------------------	----------------------------------	----------------	------------------	---------------------------------	---------------------------------------	---------------------------------------

Customer Space Cabling Infrastructure

MDA Fiber	EDA Fiber	EDA Copper	FiberGuide
-----------	-----------	------------	------------

Reference Designs and Technical Information

MDA Cabinet	MDA Cross-connect 19-in.	MDA Cross-connect FACT ODF	IDF FACT	IDF 19-in.
-------------	--------------------------	----------------------------	----------	------------



Advances in technology have enabled the data center industry to keep ahead of the insatiable demand for more capacity and bandwidth. Faster processors, higher density storage and high-speed, more cost-effective connectivity have been key contributors to this success.

Rollable ribbon fiber technology is one of the latest technology advances that helps data center managers meet demand while maximizing precious space in pathways and ducts. The inherent flexibility of the rollable ribbon matrix allows it to deliver up to twice as many fibers within the same cable diameter as conventional flat ribbon cables while maintaining the installation advantages that ribbon technology offers.

CommScope's rollable ribbon solutions extend well beyond just fiber cable. From the outside plant networks, to building entrance, meet-me rooms and even extending to customer cages, CommScope offers a comprehensive range of singlemode fiber solutions that fully exploit rollable ribbon fiber technology—offering MTDC operators and their clients faster time-to-service and better utilization of valuable space in the data center.

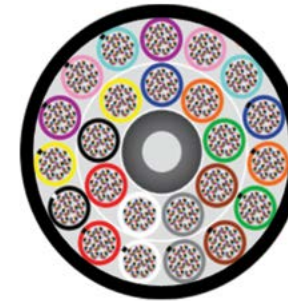

Rollable Ribbon Fiber Cable



Flat Ribbon Fiber Cable

Direct System Selection Index

BUDI	FACT ODF	UMSC	Flex Frame ODF, 19-in. Propel	FOSC 600	19-in. Splice	Rollable Ribbon Fiber	Other Products	Pre-term 19-in. Fiber	Pre-term FACT ODF Fiber	FiberGuide	Cable Mgmt Wire Baskets	Category 6A	Powered Fiber	DIN Rail	Fiber Wall Boxes	2 Post Equipment	imVision
------	----------	------	-------------------------------	----------	---------------	-----------------------	----------------	-----------------------	-------------------------	------------	-------------------------	-------------	---------------	----------	------------------	------------------	----------

Architecture System Selection Index

Colocation Campus and Building Infrastructure

Fiber Entrance, Meet-Me Room	High Fiber Count DC Interconnect	Campus Cabling	Building Cabling	IDF to Customer Cage (FACT ODF)	IDF to Customer Cage (19-in. Cabinet)	Campus Cabling for Wi-Fi and Security	MDA Fiber	EDA Fiber	EDA Copper	FiberGuide	MDA Cabinet	MDA Cross-connect 19-in.	MDA Cross-connect FACT ODF	IDF FACT	IDF 19-in.
------------------------------	----------------------------------	----------------	------------------	---------------------------------	---------------------------------------	---------------------------------------	-----------	-----------	------------	------------	-------------	--------------------------	----------------------------	----------	------------

Customer Space Cabling Infrastructure

Reference Designs and Technical Information



CommScope's rollable ribbon technology utilizes partially bonded fiber ribbons composed of 12 fibers. Unlike conventional ribbons, which are fully longitudinally bonded, rollable ribbons are partially bonded. As seen here, the partial bonding process used with rollable ribbons allows them to be easily separated and "rolled" into a cylinder, thus making much better use of space when compared with flat ribbons.

Cables containing rollable ribbon fibers offer significant advantages over flat ribbon fiber cables, including the following:

- Double the fiber density of standard matrix flat ribbons
- Smaller, lighter cables simplify handling and installation
- Significant reduction in splice time through use of mass fusion splicing
- No preferential bend (common in flat matrix ribbons)
- Easy separation for splicing or connectorization

- Smaller bend radii due to smaller cable diameter, allowing smaller telecom spaces such as closures, panels and hand holes
- Outdoor cables available in gel-free construction
- Fiber counts available from 144 to 3,456

OSP rollable ribbon fiber cables offer double the fiber counts compared with flat ribbon fiber cables as shown in the table below comparing several duct sizes.

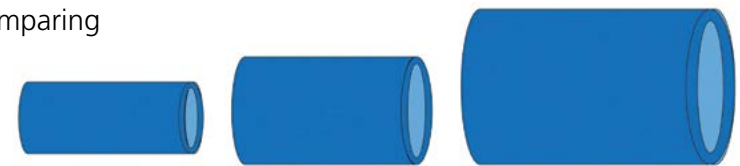

Max Fiber Count	1 in. (2.5 cm) duct	1 1/4 in. (3.2 cm) duct	2 in. (5 cm) duct
Flat Ribbon	432	864	1728
Rollable Ribbon	864	1728	3456

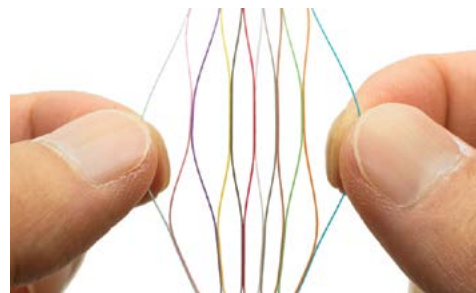

Rollable Ribbon



Conventional Flat Ribbon Matrix (Side View and Top View)

Direct System Selection Index

BUDI	FACT ODF	UMSC	Flex Frame ODF, 19-in. Propel	FOSC 600	19-in. Splice	Rollable Ribbon Fiber	Other Products	Pre-term 19-in. Fiber	Pre-term FACT ODF Fiber	FiberGuide	Cable Mgmt Wire Baskets	Category 6A	Powered Fiber	DIN Rail	Fiber Wall Boxes	2 Post Equipment	imVision
------	----------	------	-------------------------------	----------	---------------	-----------------------	----------------	-----------------------	-------------------------	------------	-------------------------	-------------	---------------	----------	------------------	------------------	----------

Architecture System Selection Index

Colocation Campus and Building Infrastructure

Fiber Entrance, Meet-Me Room	High Fiber Count DC Interconnect	Campus Cabling	Building Cabling	IDF to Customer Cage (FACT ODF)	IDF to Customer Cage (19-in. Cabinet)	Campus Cabling for Wi-Fi and Security	MDA Fiber	EDA Fiber	EDA Copper	FiberGuide	MDA Cabinet	MDA Cross-connect 19-in.	MDA Cross-connect FACT ODF	IDF FACT	IDF 19-in.
------------------------------	----------------------------------	----------------	------------------	---------------------------------	---------------------------------------	---------------------------------------	-----------	-----------	------------	------------	-------------	--------------------------	----------------------------	----------	------------

Customer Space Cabling Infrastructure

Reference Designs and Technical Information



Rollable Ribbon Non-Armored External Fiber Optic Cable	Total Number of Fibers	Fibers Per Sub-Unit	Sheath Material	Outer Diameter	Minimum Bend Radius, Loaded	Description Code	Part Number
Outdoor Non-Armored, All-Dielectric, Gel-Free, Stranded Loose Tube Rollable Ribbon Cable	1728	288	UV Stabilized	0.988 in. (25.1 mm)	14.843 in. (377 mm)	D-1728-LN-RR-F12NS/8W/99H	760239389
Outdoor Non-Armored, All-Dielectric, Gel-Free, Stranded Loose Tube Rollable Ribbon Cable	864	144	UV Stabilized	0.827 in. (21 mm)	12.362 in. (314 mm)	D-864-LN-RR-F12NS/8W/99H	760241354
Rollable Ribbon Armored External Fiber Optic Cable	Total Number of Fibers	Fibers Per Sub-Unit	Sheath Material	Outer Diameter	Minimum Bend Radius, Loaded	Description Code	Part Number
Outdoor Steel Armored, Gel-Free, Stranded Loose Tube Rollable Ribbon Cable	1728	288	UV Stabilized	1.055 in. (26.8 mm)	15.787 in. (401 mm)	D-1728-LA-RR-F12NS/8W/99H	760239858
Outdoor Steel Armored, Gel-Free, Stranded Loose Tube Rollable Ribbon Cable	864	144	UV Stabilized	0.913 in. (23.2 mm)	13.701 in. (348 mm)	D-864-LA-RR-F12NS/8W/99H	760241358
Rollable Ribbon Non-Armored Indoor / Outdoor Armored External Fiber Optic Cable	Total Number of Fibers	Fibers Per Sub-Unit	Sheath Material	Outer Diameter	Minimum Bend Radius, Loaded	Description Code	Part Number
Outdoor/Indoor LSZH Rollable Ribbon Cable with 200um Fibers	3456	576	LSZH Cca	1.083 in. (27.5mm)		Z-3456-LN-RR-F12BK/8G1/99L/200/C	760250982
Indoor/Outdoor, All-Dielectric, Low Smoke Zero Halogen (LSZH), Riser-Rated, Gel-Free, Loose Tube Rollable Ribbon Cable	1728	288	LSZH B2ca	1 in. (25.4 mm)	20 in. (508 mm)	Z-1728-LN-RR-F12BK/8G1/99H/B2	760244183
Indoor/Outdoor, All-Dielectric, Low Smoke Zero Halogen (LSZH), Riser-Rated, Gel-Free, Central Tube Rollable Ribbon Cable	864	Single Central Tube	LSZH Cca	0.768 in. (19.5 mm)	15.354 in. (390 mm)	Z-864-CN-RR-F12BK/8G/99G/C	760239025
Rollable Ribbon Armored Indoor / Outdoor Armored External Fiber Optic Cable	Total Number of Fibers	Fibers Per Sub-Unit	Sheath Material	Outer Diameter	Minimum Bend Radius, Loaded	Description Code	Part Number
Indoor/Outdoor, Riser-Rated, Gel-Free, Inner Low Smoke Zero Halogen (LSZH) Stranded Loose Tube Rollable Ribbon Cable with Aluminum Interlocking Armor and a LSZH Outer Jacket	1728	288	LSZH B2ca	1.354 in. (34.4 mm)	20.315 in. (516 mm)	Z-1728-LZ-RR-F12BK/8G1/99H/B2	760245915
Indoor/Outdoor, Interlocking Armored, Low Smoke Zero Halogen (LSZH), Riser-Rated, Gel-Free, Central Tube Rollable Ribbon Cable	864	Single Central Tube	LSZH B2ca	1.106 in. (28.1 mm)	22.126 in. (562 mm)	Z-864-CZ-RR-F12BK/8G/99G/B2	760239052
Rollable Ribbon Non-Armored Indoor Fiber Optic Cable	Total Number of Fibers	Fibers Per Sub-Unit	Sheath Material	Outer Diameter	Minimum Bend Radius, Loaded	Description Code	Part Number
Indoor, All-Dielectric, Low Smoke Zero Halogen (LSZH), Riser-Rated, Gel-Free, Loose Tube Rollable Ribbon Cable	1728	288	LSZH B2ca	1 in. (25.4 mm)	20 in. (508 mm)	N-1728-LN-RR-F12YL/8G/99H/B2	760244182
Indoor, All-Dielectric, Low Smoke Zero Halogen (LSZH), Riser-Rated, Gel-Free, Central Tube Rollable Ribbon Cable	864	Single Central Tube	LSZH Cca	0.768 in. (19.5 mm)	15.354 in. (390 mm)	N-864-CN-RR-F12YL/8G1/99G/C	760242275
Indoor, All-Dielectric, Low Smoke Zero Halogen (LSZH), Riser-Rated, Gel-Free, Central Tube Rollable Ribbon Cable	288	Single Central Tube	LSZH Cca	0.492 in. (12.5 mm)	9.843 in. (250 mm)	N-288-CN-RR-F12YL/8G1/99G/C	760239308
Indoor All-Dielectric, Low Smoke Zero Halogen (LSZH), Riser-Rated, Gel-Free, Central Tube Rollable Ribbon Cable	144	Single Central Tube	LSZH Cca	0.413 in. (10.5 mm)	8.268 in. (210 mm)	N-144-CN-RR-F12YL/8G1/99G/C	760239307

Direct System Selection Index

BUDI	FACT ODF	UMSC	Flex Frame ODF, 19-in. Propel	FOSC 600	19-in. Splice	Rollable Ribbon Fiber	Other Products	Pre-term 19-in. Fiber	Pre-term FACT ODF Fiber	FiberGuide	Cable Mgmt Wire Baskets	Category 6A	Powered Fiber	DIN Rail	Fiber Wall Boxes	2 Post Equipment	imVision
------	----------	------	-------------------------------	----------	---------------	-----------------------	----------------	-----------------------	-------------------------	------------	-------------------------	-------------	---------------	----------	------------------	------------------	----------

Architecture System Selection Index

Colocation Campus and Building Infrastructure

Fiber Entrance, Meet-Me Room	High Fiber Count DC Interconnect	Campus Cabling	Building Cabling	IDF to Customer Cage (FACT ODF)	IDF to Customer Cage (19-in. Cabinet)	Campus Cabling for Wi-Fi and Security
------------------------------	----------------------------------	----------------	------------------	---------------------------------	---------------------------------------	---------------------------------------

Customer Space Cabling Infrastructure

MDA Fiber	EDA Fiber	EDA Copper	FiberGuide
-----------	-----------	------------	------------

Reference Designs and Technical Information

MDA Cabinet	MDA Cross-connect 19-in.	MDA Cross-connect FACT ODF	IDF FACT	IDF 19-in.
-------------	--------------------------	----------------------------	----------	------------



Stranded Non-Armored Microsheath Indoor Fiber Optic Cable	Total Number of Fibers	Fibers Per Sub-Unit	Sheath Material	Outer Diameter	Minimum Bend Radius, Loaded	Description Code	Part Number
Single Jacket All-Dielectric, Gel-Free, Indoor Stranded Microsheath Tube Cable OS2	144	12	LSZH Cca	0.402 in. (10.2 mm)	7.874 in. (200 mm)	L-144-LN-8F-M12YL/14D/GY/C	760243186
Single Jacket All-Dielectric, Gel-Free, Indoor Stranded Microsheath Tube Cable OS2	96	12	LSZH Cca	0.331 in. (8.4 mm)	6.693 in. (170 mm)	POC-FOMCRO-LSZH-96X4-CCA-STD	760245018
Single Jacket All-Dielectric, Gel-Free, Indoor Stranded Microsheath Tube Cable OS2	48	12	LSZH Cca	0.26 in. (6.6 mm)	5.118 in. (130 mm)	L-048-LN-8F-M12YL/14D/GY/C	760245020
Single Jacket All-Dielectric, Gel-Free, Indoor Stranded Microsheath Tube Cable OS2	24	12	LSZH Cca	0.26 in. (6.6 mm)	5.118 in. (130 mm)	L-024-LN-8F-M12YL/14D/GY/C	760245021
Single Jacket All-Dielectric, Gel-Free, Indoor Stranded Microsheath Tube Cable OS2	12	12	LSZH Cca	0.26 in. (6.6 mm)	5.118 in. (130 mm)	L-012-LN-8F-M12YL/14D/GY/C	760245022
Distribution Non-Armored Indoor Fiber Optic Cable	Total Number of Fibers	Fibers Per Sub-Unit	Sheath Material	Outer Diameter	Minimum Bend Radius, Loaded	Description Code	Part Number
TeraSPEED® Low Smoke Zero Halogen Riser, 48 fiber multi-unit with 12 fiber subunits	48	12	LSZH Cca	0.637 in. (16.19 mm)	9.567 in. (243 mm)	N-048-DS-8W-FMUYL/C	760004291
TeraSPEED Low Smoke Zero Halogen Riser, 24 fiber single-unit, singlemode	24	N/A	LSZH B2ca	0.347 in. (8.82 mm)	5.197 in. (132 mm)	N-024-DS-8W-FSUYL/B2	760241765
TeraSPEED Low Smoke Zero Halogen Riser, 12 fiber single-unit, singlemode	12	N/A	LSZH B2ca	0.240 in. (6.1 mm)	3.622 in. (92 mm)	N-012-DS-8W-FSUYL/B2	760248874
Loose Tube Cable Outdoor, Armored	Fiber Type	Fiber Count	Jacket Material	Description Code	Part Number		
Singlemode OS2 Single Jacket/Single Armor, Gel-Free, Outdoor Stranded Loose Tube Cable, 48 fibers	OS2	48	N/A	D-048-LA-8W-F12NS	760053314		
Singlemode OS2 Single Jacket/Single Armor, Gel-Free, Outdoor Stranded Loose Tube Cable, 96 fibers	OS2	96	N/A	D-096-LA-8W-F12NS	760053348		
Singlemode OS2 Single Jacket/Single Armor, Gel-Free, Outdoor Stranded Loose Tube Cable, 144 fibers	OS2	144	N/A	D-144-LA-8W-F12NS	760053355		
Singlemode OS2 Single Jacket/Single Armor, Gel-Free, Outdoor Stranded Loose Tube Cable, 288 fibers	OS2	288	N/A	D-288-LA-8W-F12NS	760053363		

Direct System Selection Index

BUDI	FACT ODF	UMSC	Flex Frame ODF, 19-in. Propel	FOSC 600	19-in. Splice	Rollable Ribbon Fiber	Other Products	Pre-term 19-in. Fiber	Pre-term FACT ODF Fiber	FiberGuide	Cable Mgmt Wire Baskets	Category 6A	Powered Fiber	DIN Rail	Fiber Wall Boxes	2 Post Equipment	imVision
------	----------	------	-------------------------------	----------	---------------	-----------------------	----------------	-----------------------	-------------------------	------------	-------------------------	-------------	---------------	----------	------------------	------------------	----------

Architecture System Selection Index

Colocation Campus and Building Infrastructure

Fiber Entrance, Meet-Me Room	High Fiber Count DC Interconnect	Campus Cabling	Building Cabling	IDF to Customer Cage (FACT ODF)	IDF to Customer Cage (19-in. Cabinet)
------------------------------	----------------------------------	----------------	------------------	---------------------------------	---------------------------------------

Customer Space Cabling Infrastructure

Campus Cabling for Wi-Fi and Security	MDA Fiber	EDA Fiber	EDA Copper	FiberGuide
---------------------------------------	-----------	-----------	------------	------------

Reference Designs and Technical Information

MDA Cabinet	MDA Cross-connect 19-in.	MDA Cross-connect FACT ODF	IDF FACT	IDF 19-in.
-------------	--------------------------	----------------------------	----------	------------



Micro-sheath: Single Mode Indoor Fiber Cable	Description Code	Part Number	
12f SM Micro-sheath Fiber Cable	L-012-LN-8F-M12YL/14D/GY/C	760245022	
24f SM Micro-sheath Fiber Cable	L-024-LN-8F-M12YL/14D/GY/C	760245021	
48f SM Micro-sheath Fiber Cable	L-048-LN-8F-M12YL/14D/GY/C	760245020	
96f SM Micro-sheath Fiber Cable	L-096-LN-8F-M12YL/14D/GY/C	760251605	
144f SM Micro-sheath Fiber Cable	L-144-LN-8F-M12YL/14D/GY/C	760243186	
Micro-sheath: Multimode OM4 Indoor Fiber Cable	Description Code	Part Number	
12f Laserspeed 550 OM4 Multimode	L-012-LN-5K-M12AQ/14D/GY/C	760248051	
24f Laserspeed 550 OM4 Multimode	L-024-LN-5K-M12AQ/14D/GY/C	760246170	
48f Laserspeed 550 OM4 Multimode	L-048-LN-5K-M12AQ/14D/GY/C	760248052	
96f Laserspeed 550 OM4 Multimode	L-096-LN-5K-M12AQ/14D/GY/C	760251608	
144f Laserspeed 550 OM4 Multimode	L-144-LN-5K-M12AQ/14D/GY/C	760251607	
Micro-sheath: SM Indoor/Outdoor Fiber Cable	Description Code	Part Number	
12f Indoor/Outdoor SM	C-012-LN-8F-M12BK/14D/AY/D	760249261	
24f Indoor/Outdoor SM	C-024-LN-8F-M12BK/14D/AY/D	760249096	
48f Indoor/Outdoor SM	C-048-LN-8F-M12BK/14D/AY/D	760249097	
96f Indoor/Outdoor SM	C-096-LN-8F-M12BK/14D/AY/D	760249099	
144f Indoor/Outdoor SM	C-144-LN-8F-M12BK/14D/AY/D	760249100	
Fiber Optic Rollable Ribbon Breakout Kits	Fibers	Description Code	Part Number
Fiber Optic Ribbon Breakout Kit, for IFC cable, 12F/ribbon, 72F/tube, 11-15 mm central tube outside diameter, 6 tubes/leg	72	BLK-RIFC-A06D0	
Fiber Optic Rollable Ribbon Breakout Kit, 12F/ribbon, 12F/tube, 144 fiber cable	144	BLK-ROLB-A12-144	760245329
Fiber Optic Rollable Ribbon Breakout Kit, 12F/ribbon, 12F/tube, 288 fiber cable	288	BLK-ROLB-A24-288-NM	760245330
Fiber Optic Rollable Ribbon Breakout Kit, 12F/ribbon, 12F/tube, 432 fiber cable	432	BLK-ROLB-A36-432-NM	760245331
Fiber Optic Rollable Ribbon Breakout Kit, 12F/ribbon, 12F/tube, 576 fiber cable	576	BLK-ROLB-A48-576-NM	760245332
Fiber Optic Rollable Ribbon Breakout Kit, 12F/ribbon, 12F/tube, 864 fiber cable	864	BLK-ROLB-A72-864-NM	760245333

When splicing cable into the FACT Elements, use 250um fiber only.

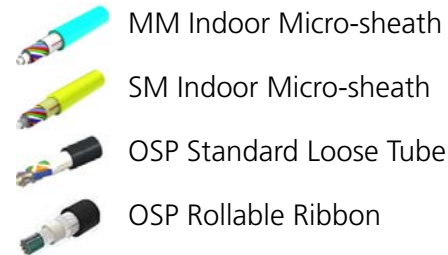

These cables are CommScope's indoor and indoor/outdoor microsheath fiber cables with 250um fiber.

- Use 250um fiber when splicing into the FACT Splice/Patch Elements
- OSP Stranded Loose Tube 250um fiber cables are suitable for the FACT Elements
- Stranded Loose Tube Rollable Ribbon type cables are also suitable for the FACT Elements

Direct System Selection Index

BUDI	FACT ODF	UMSC	Flex Frame ODF, 19-in. Propel	FOSC 600	19-in. Splice	Rollable Ribbon Fiber	Other Products	Pre-term 19-in. Fiber	Pre-term FACT ODF Fiber	FiberGuide	Cable Mgmt Wire Baskets	Category 6A	Powered Fiber	DIN Rail	Fiber Wall Boxes	2 Post Equipment	imVision
------	----------	------	-------------------------------	----------	---------------	-----------------------	----------------	-----------------------	-------------------------	------------	-------------------------	-------------	---------------	----------	------------------	------------------	----------

Architecture System Selection Index

Colocation Campus and Building Infrastructure

Fiber Entrance, Meet-Me Room	High Fiber Count DC Interconnect	Campus Cabling	Building Cabling	IDF to Customer Cage (FACT ODF)	IDF to Customer Cage (19-in. Cabinet)	Campus Cabling for Wi-Fi and Security	MDA Fiber	EDA Fiber	EDA Copper	FiberGuide	MDA Cabinet	MDA Cross-connect 19-in.	MDA Cross-connect FACT ODF	IDF FACT	IDF 19-in.
------------------------------	----------------------------------	----------------	------------------	---------------------------------	---------------------------------------	---------------------------------------	-----------	-----------	------------	------------	-------------	--------------------------	----------------------------	----------	------------

Customer Space Cabling Infrastructure

Reference Designs and Technical Information



Fiber Optic Rollable Ribbon Breakout Kits	Fibers	Description Code	Part Number
Fiber Optic Ribbon Breakout Kit, for IFC cable. 12F/ribbon, 72F/tube, 11-15 mm central tube outside diameter, 6 tubes/leg	72	BLK-RIFC-A06D0	
Fiber Optic Rollable Ribbon Breakout Kit, 12F/ribbon, 12F/tube, 144 fiber cable	144	BLK-ROLB-A12-144	760245329
Fiber Optic Rollable Ribbon Breakout Kit, 12F/ribbon, 12F/tube, 288 fiber cable	288	BLK-ROLB-A24-288-NM	760245330
Fiber Optic Rollable Ribbon Breakout Kit, 12F/ribbon, 12F/tube, 432 fiber cable	432	BLK-ROLB-A36-432-NM	760245331
Fiber Optic Rollable Ribbon Breakout Kit, 12F/ribbon, 12F/tube, 576 fiber cable	576	BLK-ROLB-A48-576-NM	760245332
Fiber Optic Rollable Ribbon Breakout Kit, 12F/ribbon, 12F/tube, 864 fiber cable	864	BLK-ROLB-A72-864-NM	760245333
Armored Cable Fitting Brackets and Accessories		Description Code	Part Number
Bracket for Armor Fitting, 1/2 NPT		BAF-1/2-NPT	760122895
Bracket for Armor Fitting, 1-1/2 NPT		BAF-1-1/2-NPT	760122937
Bracket for Armor Fitting, 1-1/4 NPT		BAF-1-1/4-NPT	760122929
Bracket for Armor Fitting, 1 NPT		BAF-1-NPT	760122911
Bracket for Armor Fitting, 3/4 NPT		BAF-3/4-NPT	760122903
Universal mounting bracket for Cabinet mount applications for attaching cables or breakout kits		UMB-CMB-LG	760239861
Universal mounting bracket for Rack mount applications for attaching cables or breakout kits		UMB-RMB-LG	760239859
InstaPATCH Plus Attachment Bracket, Rack Mounted, Five 3/4" fittings		RMB-5-3/4	760058701
InstaPATCH Plus Attachment Bracket, Rack Mounted, Six 1/2" fittings		RMB-6-1/2	760058677
InstaPATCH Plus Attachment Bracket, Rack Mounted, Six 3/8" fittings		RMB-6-3/8	760058685

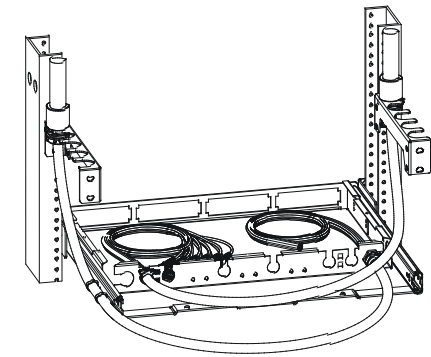
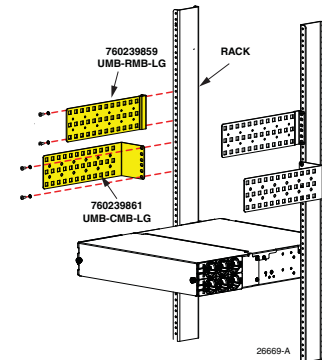

InstaPATCH Plus Attachment Bracket

Direct System Selection Index

BUDI	FACT ODF	UMSC	Flex Frame ODF, 19-in. Propel	FOSC 600	19-in. Splice	Rollable Ribbon Fiber	Other Products	Pre-term 19-in. Fiber	Pre-term FACT ODF Fiber	FiberGuide	Cable Mgmt Wire Baskets	Category 6A	Powered Fiber	DIN Rail	Fiber Wall Boxes	2 Post Equipment	imVision
------	----------	------	-------------------------------	----------	---------------	-----------------------	----------------	-----------------------	-------------------------	------------	-------------------------	-------------	---------------	----------	------------------	------------------	----------

Architecture System Selection Index

Colocation Campus and Building Infrastructure

Fiber Entrance, Meet-Me Room	High Fiber Count DC Interconnect	Campus Cabling	Building Cabling	IDF to Customer Cage (FACT ODF)	IDF to Customer Cage (19-in. Cabinet)	Campus Cabling for Wi-Fi and Security	MDA Fiber	EDA Fiber	EDA Copper	FiberGuide	MDA Cabinet	MDA Cross-connect 19-in.	MDA Cross-connect FACT ODF	IDF FACT	IDF 19-in.
------------------------------	----------------------------------	----------------	------------------	---------------------------------	---------------------------------------	---------------------------------------	-----------	-----------	------------	------------	-------------	--------------------------	----------------------------	----------	------------

Customer Space Cabling Infrastructure

Reference Designs and Technical Information



Field Fusion Splice Connectors	Connector	Fits To	Optical Performance	Connector/ Boot Color	Number of Connectors Per MID	Description Code	Part Number
Qwik-Fuse MPO Connector, OS2, Unpinned, High Optical Performance, Kit Includes 1x SMOUV Splice Protector	MPO-12/APC (Unpinned/Female)	3.0 mm round cable	Max IL 0.35 dB	Yellow/Black	1	SFC-12MP-8LL-30-YL	760249953
Qwik-Fuse MPO Connector, OS2, Pinned, High Optical Performance, Kit Includes 1x SMOUV Splice Protector	MPO-12/APC (Pinned/Male)	3.0 mm round cable	Max IL 0.35 dB	Yellow/Black	1	SFC-12MX-8LL-30-YL	760249956
Qwik-Fuse MPO Connector, OS2, Unpinned, Kit Includes 1x SMOUV Splice Protector	MPO-12/APC (Unpinned/Female)	3.0 mm round cable	Max IL 0.75 dB	Green/Black	1	SFC-12MP-8SP-30-GR	760251301
Qwik-Fuse MPO Connector, OS2, Pinned, Kit Includes 1x SMOUV Splice Protector	MPO-12/APC (Pinned/Male)	3.0 mm round cable	Max IL 0.75 dB	Green/Black	1	SFC-12MX-8SP-30-GR	760251302
MPO Connector Field Fusion Splice Accessories	Connector	Fits To	Optical Performance	Connector/ Boot Color	Number of Connectors Per MID	Description Code	Part Number
Sumitomo Mass Fusion Splicer	Not supplied by CommScope. Please contact Sumitomo, or one of their approved partners, for further details.						Type-Q101-M12
Qwik-Fuse MPO Connector Splice Holder	Not supplied by CommScope. Please contact Sumitomo, or one of their approved partners, for further details.						FHM-12-MPO-MTL
Qwik-Fuse MPO Termination Kit (includes: Assembly Platform, Ferrule Holder, Instruction Sheet, Jacket Stripper/Slitting Tool, Magnifier, Marker, Ribbonizing Glue, Ribbonizing Tool, Soft Case)					1	KIT-TERMINATION-QWIK MPO	760188698



Qwik-Fuse MPO Connector, UNPINNED, Singlemode-APC, Green, for 3.0 mm round cable

Direct System Selection Index

BUDI	FACT ODF	UMSC	Flex Frame ODF, 19-in. Propel	FOSC 600	19-in. Splice	Rollable Ribbon Fiber	Other Products	Pre-term 19-in. Fiber	Pre-term FACT ODF Fiber	FiberGuide	Cable Mgmt Wire Baskets	Category 6A	Powered Fiber	DIN Rail	Fiber Wall Boxes	2 Post Equipment	imVision
------	----------	------	-------------------------------	----------	---------------	-----------------------	----------------	-----------------------	-------------------------	------------	-------------------------	-------------	---------------	----------	------------------	------------------	----------

Architecture System Selection Index

Colocation Campus and Building Infrastructure

Fiber Entrance, Meet-Me Room	High Fiber Count DC Interconnect	Campus Cabling	Building Cabling	IDF to Customer Cage (FACT ODF)	IDF to Customer Cage (19-in. Cabinet)	Campus Cabling for Wi-Fi and Security	MDA Fiber	EDA Fiber	EDA Copper	FiberGuide	MDA Cabinet	MDA Cross-connect 19-in.	MDA Cross-connect FACT ODF	IDF FACT	IDF 19-in.
------------------------------	----------------------------------	----------------	------------------	---------------------------------	---------------------------------------	---------------------------------------	-----------	-----------	------------	------------	-------------	--------------------------	----------------------------	----------	------------

Customer Space Cabling Infrastructure

Reference Designs and Technical Information



LC/LC UPC Singlemode

	Length	Description Code	Part Number
 <p>Ultra Low Loss Singlemode, LC Uniboot to LC Uniboot, 1.5 mm Duplex Fiber Patch Cord, Low Smoke Zero Halogen/Riser</p>	1 m	UFGLLULK2-JXM001	UFGLLULK2
	2 m	UFGLLULK2-JXM002	UFGLLULK2
	3 m	UFGLLULK2-JXM003	UFGLLULK2
	5 m	UFGLLULK2-JXM005	UFGLLULK2
	7 m	UFGLLULK2-JXM007	UFGLLULK2
	10 m	UFGLLULK2-JXM010	UFGLLULK2

LC/SC UPC Singlemode

	Length	Description Code	Part Number
 <p>Fiber Optic Patch Cord, Duplex, Singlemode, LC/UPC to SC/UPC, yellow, LSZH/Riser</p>	1 m	OCJ-L1-01MASHA-S1	
	2 m	OCJ-L1-02MASHA-S1	
	3 m	OCJ-L1-03MASHA-S1	CC0905-000
	5 m	OCJ-L1-05MASHA-S1	CC0906-000
	7 m	OCJ-L1-07MASHA-S1	
	10 m	OCJ-L1-10MASHA-S1	CC0908-000

Cable Management	Description Code	Part Number
Overlength storage, 4U	N/A	1671711-1
Horizontal cable through, 2U, single sided	HKT-19-SS-2U	760072959
Horizontal cable through, 3U, single sided	HKT-19-SS-3U	760072967
Cable Manager 1U	N/A	1671495-1
Cable Manager 2U	N/A	1671495-2
Cable Manager 4U	N/A	1671495-4
Cable Manager 6U	N/A	1671495-6
Cable Manager 15U	N/A	1-1671495-5
Filler/Blank Panel, 1U x 19-in., Solid, Black	FPANEL-19-1U	760162065
1U Patchcord Management	HCM-19-SS-1U-EMEA	760038240

Direct System Selection Index

BUDI	FACT ODF	UMSC	Flex Frame ODF, 19-in. Propel	FOSC 600	19-in. Splice	Rollable Ribbon Fiber	Other Products	Pre-term 19-in. Fiber	Pre-term FACT ODF Fiber	FiberGuide	Cable Mgmt Wire Baskets	Category 6A	Powered Fiber	DIN Rail	Fiber Wall Boxes	2 Post Equipment	imVision
------	----------	------	-------------------------------	----------	---------------	-----------------------	----------------	-----------------------	-------------------------	------------	-------------------------	-------------	---------------	----------	------------------	------------------	----------

Architecture System Selection Index

Colocation Campus and Building Infrastructure

Fiber Entrance, Meet-Me Room	High Fiber Count DC Interconnect	Campus Cabling	Building Cabling	IDF to Customer Cage (FACT ODF)	IDF to Customer Cage (19-in. Cabinet)	Campus Cabling for Wi-Fi and Security	MDA Fiber	EDA Fiber	EDA Copper	FiberGuide	MDA Cabinet	MDA Cross-connect 19-in.	MDA Cross-connect FACT ODF	IDF FACT	IDF 19-in.
------------------------------	----------------------------------	----------------	------------------	---------------------------------	---------------------------------------	---------------------------------------	-----------	-----------	------------	------------	-------------	--------------------------	----------------------------	----------	------------

Customer Space Cabling Infrastructure

Reference Designs and Technical Information



Pre-terminated Fiber Systems

Pre-terminated 19-in. Fiber

Pre-terminated FACT ODF Fiber



Select a product for more information.

EPX

48 ports LC-D or 32 ports MPO

Basic labeling

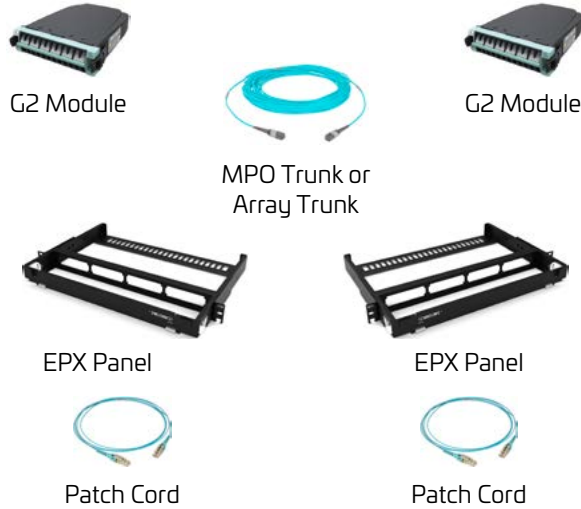

Propel

72 ports MPO or 144 ports SN or 72 ports LC-D

Front cable management

Labeling option (printer support)

Sliding tray for better cable modules access

Panels available in 1, 2 and 4RU

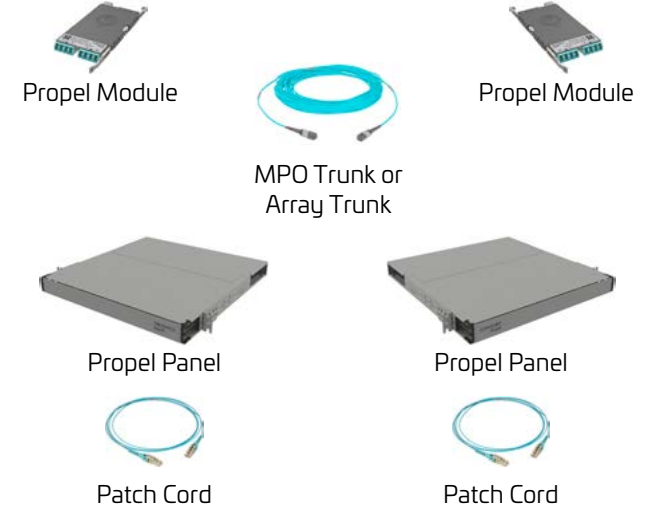

HD

48 ports LC-D or 32 ports MPO

Front cable management

Labeling option (printer support)

Sliding tray for easier cable/modules access

Panels available in 1, 2 and 4RU

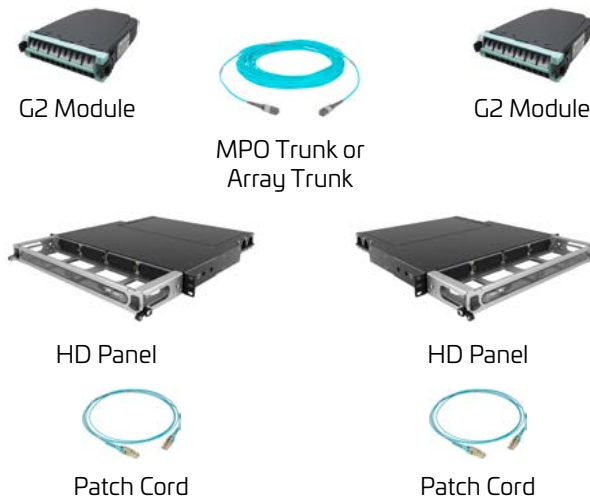

M4800 Mixed Media

For mixed copper and fiber installations

24 RJ45 Ports and 24 LC-D ports

No cable management

Basic labeling

Panels available in 1RU

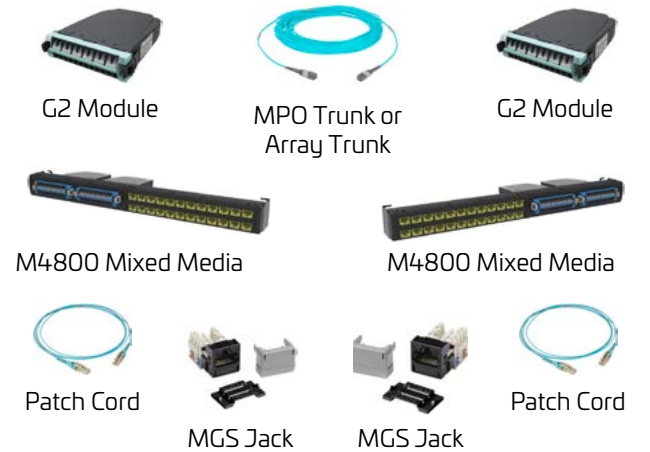

Direct System Selection Index

BUDI	FACT ODF	UMSC	Flex Frame ODF, 19-in. Propel	FOSC 600	19-in. Splice	Rollable Ribbon Fiber	Other Products	Pre-term 19-in. Fiber	Pre-term FACT ODF Fiber	FiberGuide	Cable Mgmt Wire Baskets	Category 6A	Powered Fiber	DIN Rail	Fiber Wall Boxes	2 Post Equipment	imVision
------	----------	------	-------------------------------	----------	---------------	-----------------------	----------------	-----------------------	-------------------------	------------	-------------------------	-------------	---------------	----------	------------------	------------------	----------

Architecture System Selection Index

Colocation Campus and Building Infrastructure

Fiber Entrance, Meet-Me Room	High Fiber Count DC Interconnect	Campus Cabling	Building Cabling	IDF to Customer Cage (FACT ODF)	IDF to Customer Cage (19-in. Cabinet)	Campus Cabling for Wi-Fi and Security
------------------------------	----------------------------------	----------------	------------------	---------------------------------	---------------------------------------	---------------------------------------

Customer Space Cabling Infrastructure

MDA Fiber	EDA Fiber	EDA Copper	FiberGuide
-----------	-----------	------------	------------











Reference Designs and Technical Information

MDA Cabinet	MDA Cross-connect 19-in.	MDA Cross-connect FACT ODF	IDF FACT	IDF 19-in.
-------------	--------------------------	----------------------------	----------	------------



Review Pre-terminated 19-in. Fiber System Selection [here](#).

EPX **HD** **Propel**

Fits to		Fits to Reference Designs	RU	Description Code	Part Number
	EPX Fiber Panel EPX 1U open fixed panel, accepts (4) G2 style splice cassettes, modules or adapter packs, providing up to 48 duplex LC ports		1	EPX-1U-MOD-OPEN-FX	760251098
Fits to	HD Fiber Panels	Fits to Reference Designs	RU	Description Code	Part Number
	High Density 1U modular cassette sliding Panel, accepts (4) G2 modules or adapter packs, providing up to 48 duplex LC ports, or up to 32 MPO ports		1	HD-1U	760209940
	High Density 2U modular cassette sliding Panel, accepts (8) InstaPATCH 360 modules or MPO panels, providing up to 96 duplex LC ports or up to 64 MPO ports		2	HD-2U	760209957
Fits to	Propel Fiber Panels	Fits to Reference Designs	RU	Description Code	Part Number
	Propel sliding tray fiber panel, accepts Propel ULL modules or adapter packs, providing up to 72 duplex LC ports, 72 MPO ports or 288 SN ports		1	PPL-1U	760252002
	Propel sliding tray fiber panel, accepts Propel ULL modules or adapter packs, providing up to 144 duplex LC ports, 144 MPO ports or 576 SN ports		2	PPL-2U	760252003
	Propel sliding tray fiber panel, accepts Propel ULL modules or adapter packs, providing up to 288 duplex LC ports, 288 MPO ports or 576 SN ports		4	PPL-4U	760252004
Fits to	Accessories for HD Panel			Description Code	Part Number
	Patch cord/array trunk fitting kit with 12 cable glands				760242678
	Trunk fitting kit with 12 cable glands				760242679
	G2 footprint accessories label kit			G2 FLEX LABEL KIT (12pcs)	760245472
	Patch cord fitting kit with 12 cable glands. Accepts up to 4 MPO patch cables with an od of 3.0mm				760242678
	Trunk fitting kit with 12 cable glands. Accepts upto 4 MPO trunk cables with an od of 5.4mm				760242679

Direct System Selection Index

BUDI	FACT ODF	UMSC	Flex Frame ODF, 19-in. Propel	FOSC 600	19-in. Splice	Rollable Ribbon Fiber	Other Products	Pre-term 19-in. Fiber	Pre-term FACT ODF Fiber	FiberGuide	Cable Mgmt Wire Baskets	Category 6A	Powered Fiber	DIN Rail	Fiber Wall Boxes	2 Post Equipment	imVision
------	----------	------	-------------------------------	----------	---------------	-----------------------	----------------	-----------------------	-------------------------	------------	-------------------------	-------------	---------------	----------	------------------	------------------	----------

Architecture System Selection Index

Colocation Campus and Building Infrastructure						Customer Space Cabling Infrastructure					Reference Designs and Technical Information				
Fiber Entrance, Meet-Me Room	High Fiber Count DC Interconnect	Campus Cabling	Building Cabling	IDF to Customer Cage (FACT ODF)	IDF to Customer Cage (19-in. Cabinet)	Campus Cabling for Wi-Fi and Security	MDA Fiber	EDA Fiber	EDA Copper	FiberGuide	MDA Cabinet	MDA Cross-connect 19-in.	MDA Cross-connect FACT ODF	IDF FACT	IDF 19-in.



Review Pre-terminated 19-in. Fiber System Selection here.

EPX HD Propel

Fits to	Propel Modules	Connector	Fiber	Module	Description Code	Part Number
	Propel ULL Singlemode MPO-12 Distribution Module, 12 duplex LC/UPC to 2X12f MPO/APC non-pinned, Method B Enhanced	MPO12	OS2	Distribution	PPL-DM-12AU-24LC-SM-BEU	760252348
	Propel pass-through adapter pack, 12 MPO ports, Type B	Universal MPO12	Universal	MPO Adapter Pack	PPL-AP-12-MPO-ALL-B	760252374
	Propel ULL Multimode OM4 MPO-12 Distribution Module, 12 duplex LC to 2X12f MPO/UPC non-pinned, Method B Enhanced	MPO12	OM4	Distribution	PPL-DM-12U-24LC-OM4-BEU	760252346
	Propel ULL Multimode OM5 MPO-12 Distribution Module, 12 duplex LC to 2X12f MPO/UPC non-pinned, Method B Enhanced	MPO12	OM5	Distribution	PPL-DM-12U-24LC-OM5-BEU	760252347
	Propel pass-through adapter pack, singlemode, 6 duplex LC/UPC ports	LC	OS2	LC Adapter Pack	PPL-AP-12-LC-SM	760252362
	Propel pass-through adapter pack, multimode OM4, 6 duplex LC ports	LC	OM4	LC Adapter Pack	PPL-AP-12-LC-OM4	760252363
	Propel pass-through adapter pack, multimode OM5, 6 duplex LC ports	LC	OM5	LC Adapter Pack	PPL-AP-12-LC-OM5	760252364
Fits to	G2 Fiber Modules/Adapter Packs	Connector	Fiber	Module	Description Code	Part Number
	G2 ULL MPO-12 distribution module, 24LC to 2x12f MPO unpinned, OM5 Wideband, internal shutter	MPO12	OM5	Distribution	DM12-24LC-WB-ULL	760236111
	G2 ULL MPO-12 distribution module, 24LC to 2x12f MPO unpinned, OM4 internal shutter	MPO12	OM4	Distribution	DM12-24LC-LS-ULL	760236110
	G2 ULL 2x3 LazrSPEED® OM4 Conversion Module, (2) MPO-12 unpinned ports rear, (3) MPO-8 pinned front	MPO12	OM4	Conversion	CM12-2x3-LS-ULL	760237217
	G2 ULL 2x3 LazrSPEED OM5 Conversion Module, (2) MPO-12 unpinned ports rear, (3) MPO-8 pinned front	MPO12	OM5	Conversion	CM12-2x3-WB-ULL	760237218
	G2 ULL MPO-12 distribution module, 24LC to 2x12f MPOs unpinned, singlemode internal shutter	MPO12	OS2	Distribution	DM12-24LC-SM-ULL	760238083
	G2 ULL 2x3 Singlemode Conversion Module, (2) MPO-12 unpinned ports rear, (3) MPO-8 pinned front	MPO12	OS2	Conversion	CM12-2X3-SM-ULL	760237216
	G2 Distribution Adapter Pack, 36ODP-8MPO, 8 x MPO	N/A	Universal	MPO Adapter Pack	36ODP-8MPO	760107524
	G2 Distribution Adapter Pack 24 LC with internal shutters, Multimode OM4 Aqua	N/A	OM4	LC Adapter Pack	36ODPis-24LC-LS	760216754
	G2 Distribution Adapter Pack 24 LC with internal shutters, Multimode OM5 Lime Green	N/A	OM5	LC Adapter Pack	36ODPis-24LC-WB	760236041
	G2 Distribution Adapter Pack 24 LC with internal shutters, Singlemode Blue	N/A	OS2	LC Adapter Pack	36ODPis-24LC-SM	760216762
	G2 blank adapters, 4 pcs	N/A	N/A	Blank Panel	36OG2-MOD-BLANK-4PK	760109462

Direct System Selection Index

BUDI	FACT ODF	UMSC	Flex Frame ODF, 19-in. Propel	FOSC 600	19-in. Splice	Rollable Ribbon Fiber	Other Products	Pre-term 19-in. Fiber	Pre-term FACT ODF Fiber	FiberGuide	Cable Mgmt Wire Baskets	Category 6A	Powered Fiber	DIN Rail	Fiber Wall Boxes	2 Post Equipment	imVision
------	----------	------	-------------------------------	----------	---------------	-----------------------	----------------	-----------------------	-------------------------	------------	-------------------------	-------------	---------------	----------	------------------	------------------	----------

Architecture System Selection Index

Colocation Campus and Building Infrastructure						Customer Space Cabling Infrastructure					Reference Designs and Technical Information						
Fiber Entrance, Meet-Me Room	High Fiber Count DC Interconnect	Campus Cabling	Building Cabling	IDF to Customer Cage (FACT ODF)	IDF to Customer Cage (19-in. Cabinet)	Campus Cabling for Wi-Fi and Security	MDA Fiber	EDA Fiber	EDA Copper	FiberGuide	MDA Cabinet	MDA Cross-connect 19-in.	MDA Cross-connect FACT ODF	IDF FACT	IDF 19-in.		



Review Pre-terminated 19-in. Fiber System Selection here.

EPX HD Propel

Fits to	Cable Management	Fits to Reference Designs	Description Code	Part Number
	Overlength storage, 4U			1671711-1
	Horizontal cable through, 2U, single sided		HKT-19-SS-2U	760072959
	Horizontal cable through, 3U, single sided		HKT-19-SS-3U	760072967
	Cable Manager 1U			1671495-1
	Cable Manager 2U			1671495-2
	Cable Manager 4U			1671495-4
	Cable Manager 6U			1671495-6
	Cable Manager 15U			1-1671495-5
	Filler/Blank Panel, 1U x 19-in., Solid, Black		FPANEL-19-1U	760162065
	1U Patchcord Management		HCM-19-SS-1U-EMEA	760038240
	Universal Mounting Bracket		360-UMB	760117564
	3 in (76 mm) Channel x 94 in (239 mm) H - 19 in (482.6 mm) Overhead Patch Panel Rack (4U) 3/8 Sq Punch, Black		OVRHRACK	760157800
	3 in (76 mm) Channel x 94in (239 mm) H - 19 in (482.6 mm) Overhead Patch Panel Rack (4U) 3/8 Sq Punch, with Mini Vertical Cable Management, Black		OVRHRACKVCM	760158592
	Mini Vertical Cable Management for Overhead Patch Panel Rack, 4U, black		OVRHDVCM	760164061
	Overhead Rack-to-Wire Basket Installation Kit		OVRHRACKBSKTKIT	760165282
	3 in (76 mm) Channel x 9.5 in (239 mm) H - 19 in (482.6 mm) Overhead Patch Panel Rack (6U) 3/8 Sq Punch, Black		OVRHRACK6U	760169581
	3 in (76 mm) Channel x 12.9 in (327.66 mm) H - 19 in (482.6 mm) Overhead Patch Panel Rack (6U) 3/8 Sq Punch, with Mini Vertical Cable Management, Black		OVRHRACKVCM6U	760169599
	Cabinet mount accessory bracket kit, including Gland Adapter cable bracket, for 6 glands, with ComScope cable mounting feature		EHD-CMB-GAB	EHD-CMB-GAB
	Rack mount accessory bracket kit, including Gland Adapter cable bracket, for 6 glands, with ComScope cable mounting feature		EHD-RMB-GAB	EHD-RMB-GAB
	Universal Connectivity Platform (UCP) Xtra-U Aerial Holder Kit, wire-mesh, mix media, galvanized, 2RU. Check panel compatability with local ComScope Technical Team			1-1671603-1
	Universal Connectivity Platform (UCP) Xtra-U Aerial Holder Kit, wire-mesh, mix media, galvanized, 4RU. Check panel compatability with local ComScope Technical Team			1-1671603-2
	Universal Connectivity Platform (UCP) Xtra-U Aerial Panel Holder Kit for FGS, mixed media, 2RU, galvanized. Check panel compatability with local ComScope Technical Team			1-1671603-3
	Universal Connectivity Platform (UCP) Xtra-U Aerial Panel Holder Kit for FGS, mixed media, 4RU, galvanized. Check panel compatability with local ComScope Technical Team			1-1671603-4



Direct System Selection Index

BUDI	FACT ODF	UMSC	Flex Frame ODF, 19-in. Propel	FOSC 600	19-in. Splice	Rollable Ribbon Fiber	Other Products	Pre-term 19-in. Fiber	Pre-term FACT ODF Fiber	FiberGuide	Cable Mgmt Wire Baskets	Category 6A	Powered Fiber	DIN Rail	Fiber Wall Boxes	2 Post Equipment	imVision
------	----------	------	-------------------------------	----------	---------------	-----------------------	----------------	-----------------------	-------------------------	------------	-------------------------	-------------	---------------	----------	------------------	------------------	----------

Architecture System Selection Index

Colocation Campus and Building Infrastructure

Fiber Entrance, Meet-Me Room	High Fiber Count DC Interconnect	Campus Cabling	Building Cabling	IDF to Customer Cage (FACT ODF)	IDF to Customer Cage (19-in. Cabinet)	Campus Cabling for Wi-Fi and Security	MDA Fiber	EDA Fiber	EDA Copper	FiberGuide	MDA Cabinet	MDA Cross-connect 19-in.	MDA Cross-connect FACT ODF	IDF FACT	IDF 19-in.
------------------------------	----------------------------------	----------------	------------------	---------------------------------	---------------------------------------	---------------------------------------	-----------	-----------	------------	------------	-------------	--------------------------	----------------------------	----------	------------

Customer Space Cabling Infrastructure

Reference Designs and Technical Information



Review Pre-terminated 19-in. Fiber System Selection here.

M4800 Mixed Media

Mixed Media Solution for M4800 Style Panel	Quantity	Description Code	Part Number
M4800 1U Modular Panel, Empty	1	M4800-1U-E	760253192
M4800 DDM for M-series Jacks, Black (MGS600/MGS400)	1	M4800-DDM	760253193
M4800 DDM for G2-modules, Black (5 EA/pkg)	1	M4800-G2-DDM-5	760253194
M4800 LC-Duplex Adapter, Black (24 EA/pkg)	1	M4800 LCD-Adapter-24	760253195
GigaSPEED XL MGS400 Series Category 6 U/UTP Information Outlet, black	1		700206667
GigaSPEED X10D MGS600 Series Information Outlet, black	1		760092361
Fiber Optic Duplex Adapter, Singlemode LC/UPC, blue, flangeless	1		760115238 CP7685-000
Fiber Optic Duplex Adapter, Multimode LC/UPC, OM3/OM4, aqua, flangeless	1		760248483 EHI458-002

CommScope offers a high-density mixed media solution for the Asia Pacific region and is ideal in data centers, providing flexibility and scalability for rack space optimization. The mixed media solution allows copper and fiber in a one rack unit M4800 style panel.

- Includes jacks, panels, modules and accessories
- Typical configuration of 24-fiber and 24-copper ports on the same panel
- Ideal for scenarios where deployments begin with copper ports with additional fiber ports added in phase two
- Relevant for emerging markets in ASEAN or local data center requirements
- Backed by our SYSTIMAX 25-year extended product and Application Assurance warranty

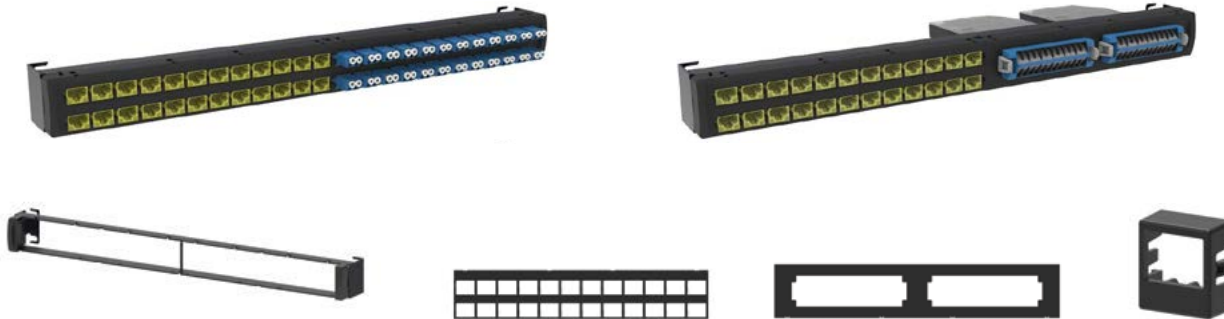

Direct System Selection Index

BUDI	FACT ODF	UMSC	Flex Frame ODF, 19-in. Propel	FOSC 600	19-in. Splice	Rollable Ribbon Fiber	Other Products	Pre-term 19-in. Fiber	Pre-term FACT ODF Fiber	FiberGuide	Cable Mgmt Wire Baskets	Category 6A	Powered Fiber	DIN Rail	Fiber Wall Boxes	2 Post Equipment	imVision
------	----------	------	-------------------------------	----------	---------------	-----------------------	----------------	-----------------------	-------------------------	------------	-------------------------	-------------	---------------	----------	------------------	------------------	----------

Architecture System Selection Index

Colocation Campus and Building Infrastructure

Fiber Entrance, Meet-Me Room	High Fiber Count DC Interconnect	Campus Cabling	Building Cabling	IDF to Customer Cage (FACT ODF)	IDF to Customer Cage (19-in. Cabinet)
------------------------------	----------------------------------	----------------	------------------	---------------------------------	---------------------------------------

Customer Space Cabling Infrastructure

Campus Cabling for Wi-Fi and Security	MDA Fiber	EDA Fiber	EDA Copper	FiberGuide
---------------------------------------	-----------	-----------	------------	------------

Reference Designs and Technical Information

MDA Cabinet	MDA Cross-connect 19-in.	MDA Cross-connect FACT ODF	IDF FACT	IDF 19-in.
-------------	--------------------------	----------------------------	----------	------------



Review Pre-terminated 19-in. Fiber System Selection here.

All cable assemblies on this page fit to:

EPX

HD

Evolve Mixed Media

SYSTIMAX ULL Pre-terminated Trunk Cables

12-fiber MPO connector-based modules available in LazrSPEED 550 OM4 and LazrSPEED OM5 Wideband multimode fiber solutions

12-fiber MPO connector-based modules available in TeraSPEED singlemode fiber solutions

Factory-terminated and tested trunk cables provide superior quality and performance for field connections

Reliable transmit-to-receive connectivity using Method B Enhanced polarity maintenance maximizes administrative convenience

Simplified reconfiguration for moves, adds and changes (MACs)

Easy upgrade path to parallel transmission and associated applications, and increased value of existing infrastructure

SYSTIMAX ULL trunks are provisioned with pins to interface with G2 and Propel ULL modules (without pins)



SYSTIMAX ULL MPO-12 Trunk Cables

1 U	2 3	3 X	4 5 M X	6 7 M X	8 A	9 10 11 D - M	12 A	13 F	14-16 010	
Construction type U Ultra-Low Loss	Family 3 Trunk, LSZH/Riser, CPR Class B2ca G Trunk, LSZH/Riser, CPR Class Dca	Fiber type G TeraSPEED singlemode (A2) X LazrSPEED 550 multimode V LazrSPEED OM5 WB multimode	Termination end A MX MPO (pinned)	Termination end B MX MPO (pinned)	Construction A 12 Fiber PmP	Fiber count D 12-fiber F 24-fiber H 48-fiber K 72-fiber L 96-fiber M 144-fiber	Color M Aqua N Lime green J Yellow LazrSPEED OM4 standard is aqua LazrSPEED OM5 standard is lime green TeraSPEED singlemode standard is yellow	Options A No gland B With gland C With pulling eye C for cabling between HD & EHD panels A for cabling between AGL panels and between AGL panels and EHD/HD panels Use accessory gland for patch cords in case gland is required on one side only	Unit of measure F Feet M Meter	Length 010-999 Feet 003-305 Meter

Fits to: **Propel**



Propel MPO-12 Singlemode & Multimode Trunk Cables

1 U	2 G	3 X	4 5 M X	6 7 M X	8 C	9 10 11 D - M	12 J	13 F	14-16 010	
Construction type U Ultra-low loss	Cable family 3 Trunk, LSZH CPR B2ca G Trunk, Plenum J Trunk, Dual Rated (OFNR/LSZH)	Fiber type G singlemode (A2) X OM4 multimode V OM5 WB multimode	Connector 1 MX 12F MPO (Pinned)	Connector 2 MX 12F MPO (Pinned)	Cordage size C 12F PmP Trunk, 2.0mm SU	Fiber count D 12-fiber F 24-fiber G 36-fiber H 48-fiber K 72-fiber L 96-fiber M 144-fiber N 192-fiber P 288-fiber	Color M OM4 Aqua N OM5 Lime green J Yellow	Breakout length J 22" Break Propel No Pull Grip K 22" Break Propel Pull Grip	UOM F Feet M Meter	Length 010-999 ft 003-305 m

Note: For MPO-8, MPO-16, and MPO-24 products and other trunk configurations please contact your CommScope sales representative.

Direct System Selection Index

BUDI	FACT ODF	UMSC	Flex Frame ODF, 19-in. Propel	FOSC 600	19-in. Splice	Rollable Ribbon Fiber	Other Products	Pre-term 19-in. Fiber	Pre-term FACT ODF Fiber	FiberGuide	Cable Mgmt Wire Baskets	Category 6A	Powered Fiber	DIN Rail	Fiber Wall Boxes	2 Post Equipment	imVision
------	----------	------	-------------------------------	----------	---------------	-----------------------	----------------	-----------------------	-------------------------	------------	-------------------------	-------------	---------------	----------	------------------	------------------	----------

Architecture System Selection Index

Colocation Campus and Building Infrastructure

Fiber Entrance, Meet-Me Room	High Fiber Count DC Interconnect	Campus Cabling	Building Cabling	IDF to Customer Cage (FACT ODF)	IDF to Customer Cage (19-in. Cabinet)	Campus Cabling for Wi-Fi and Security	MDA Fiber	EDA Fiber	EDA Copper	FiberGuide	MDA Cabinet	MDA Cross-connect 19-in.	MDA Cross-connect FACT ODF	IDF FACT	IDF 19-in.
------------------------------	----------------------------------	----------------	------------------	---------------------------------	---------------------------------------	---------------------------------------	-----------	-----------	------------	------------	-------------	--------------------------	----------------------------	----------	------------

Customer Space Cabling Infrastructure

Reference Designs and Technical Information



Review Pre-terminated 19-in. Fiber System Selection here.

All cable assemblies on this page fit to:

EPX

HD

Evolve Mixed Media

SYSTIMAX ULL MPO Array Trunks

12-fiber MPO connector-based modular design enables simple connections

Array trunks are constructed with 550 OM4 and OM5 Wideband and singlemode fibers

Factory-terminated and tested for instant field connections giving guaranteed quality and performance

MPO-MPO array trunks are constructed with 3.0 mm PmP array cords

SYSTIMAX ULL MPO/LC Array Cords

TeraSPEED singlemode or multimode 12 fiber MPO connectors ensure fast and simple connections

Available in LazrSPEED 550 OM4 and LazrSPEED 550 OM5 Wideband multimode fibers

Factory-terminated and tested trunk cables provide superior quality and performance for field connections

MPO-LC array fanouts are constructed with 1.6 mm reinforced zipcord furcation tubing for outstanding durability and dependability

Array fanouts available with multiple breakout lengths for simple installation



SYSTIMAX ULL MPO Array Trunks

1 U	2 R	3 X	4 M	5 X	6 M	7 X	8 G	9 D	10 -	11 M	12 E	13 F	14-16 010
Construction type U Ultra-Low Loss	Cable family R LSZH array	Fiber type G TeraSPEED singlemode (A2) X LazrSPEED 550 multimode V LazrSPEED OM5 WB multimode	Connector 1 MX 12f MPO (pinned)		Connector 2 MX 12f MPO (pinned)		Cordage size G 12-fiber PmP Array Cord	Fiber count D 12-fiber	Color M Aqua N Lime green J Yellow LazrSPEED OM4 standard is aqua LazrSPEED OM5 standard is lime green TeraSPEED singlemode standard is yellow	Breakout length D 12 in breakout, no gland E 24 in breakout, no gland H 48 in breakout, no gland L 72 in breakout, no gland P 96 in breakout, no gland A No gland, no breakout		Unit of measure F Feet M Meter	Length minimal length based on breakout 12 in 3-999 ft 24 in 4-999 ft 48 in 6-999 ft 72 in 8-999 ft 96 in 10-999 ft 12 in 1-305 m 24-48 in 2-305 m 72 in 3-305 m 96 in 4-305 m Total length includes the breakout

*2P, 2X and 2C only available for multimode fiber



SYSTIMAX ULL MPO/LC Array Cords

1 U	2 N	3 X	4 M	5 P	6 L	7 C	8 G	9 D	10 -	11 M	12 E	13 F	14-16 010
Construction type U Ultra-Low Loss	Cable family N LSZH array	Fiber type G TeraSPEED singlemode (A2) X LazrSPEED 550 multimode V LazrSPEED OM5 WB multimode	Connector 1 MP 12f MPO (unpinned)		Connector 2 LC LC connector		Cordage size G 12-fiber PmP Array Cord	Fiber count D 12-fiber	Color M Aqua N Lime green J Yellow LazrSPEED OM4 standard is aqua LazrSPEED OM5 standard is lime green TeraSPEED singlemode standard is yellow	Breakout length D 12 in breakout, no gland E 24 in breakout, no gland H 48 in breakout, no gland L 72 in breakout, no gland P 96 in breakout, no gland		Unit of measure F Feet M Meter	Length minimal length based on breakout 12 in 3-999 ft 24 in 4-999 ft 48 in 6-999 ft 72 in 8-999 ft 96 in 10-999 ft 12 in 1-305 m 24-48 in 2-305 m 72 in 3-305 m 96 in 4-305 m Other lengths available

Note: For MPO-8 and MPO-24 products and other trunk configurations please contact your CommScope sales representative.

Direct System Selection Index

BUDI	FACT ODF	UMSC	Flex Frame ODF, 19-in. Propel	FOSC 600	19-in. Splice	Rollable Ribbon Fiber	Other Products	Pre-term 19-in. Fiber	Pre-term FACT ODF Fiber	FiberGuide	Cable Mgmt Wire Baskets	Category 6A	Powered Fiber	DIN Rail	Fiber Wall Boxes	2 Post Equipment	imVision
------	----------	------	-------------------------------	----------	---------------	-----------------------	----------------	-----------------------	-------------------------	------------	-------------------------	-------------	---------------	----------	------------------	------------------	----------

Architecture System Selection Index

Colocation Campus and Building Infrastructure

Fiber Entrance, Meet-Me Room	High Fiber Count DC Interconnect	Campus Cabling	Building Cabling	IDF to Customer Cage (FACT ODF)	IDF to Customer Cage (19-in. Cabinet)	Campus Cabling for Wi-Fi and Security	MDA Fiber	EDA Fiber	EDA Copper	FiberGuide	MDA Cabinet	MDA Cross-connect 19-in.	MDA Cross-connect FACT ODF	IDF FACT	IDF 19-in.
------------------------------	----------------------------------	----------------	------------------	---------------------------------	---------------------------------------	---------------------------------------	-----------	-----------	------------	------------	-------------	--------------------------	----------------------------	----------	------------

Customer Space Cabling Infrastructure

Reference Designs and Technical Information



Review Pre-terminated 19-in. Fiber System Selection here.

All cable assemblies on this page fit to:

EPX
HD
Propel
Evolve Mixed Media



SYSTIMAX ULL LC-LC Pre-terminated Array Trunks

LC/LC trunks, 24 f	Patch Cord Type	Jacket Material	Fiber Type	Description Code	Part Number
LC/LC Microdistribution-cable, 12 x LC Duplex uniboot on each side, flexible cable construction, OD 3 mm	N/A	LSZH/Riser	OM4	URXLULUHF	URXLULUHF
LC/LC Microdistribution-cable, 12 x LC Duplex uniboot on each side, flexible cable construction, OD 3 mm	N/A	LSZH/Riser	OM5	URVLULUHF	URVLULUHF
LC/LC Microdistribution-cable, 12 x LC Duplex uniboot on each side, flexible cable construction, OD 3 mm	N/A	LSZH/Riser	OS2	FRWLULUHF	FRWLULUHF

SYSTIMAX ULL Patch Cords

Patch Cords	Patch Cord Type	Application	Fiber Type	Description Code	Part Number
Ultra Low Loss (ULL) LazrSPEED 550 OM4 LC Uniboot to LC Uniboot, Fiber Patch Cord, 1.5 mm Duplex, LSZH/Riser	LC-D to LC-D, 1.5 mm diameter, LSZH/Riser	Distribution/XC	OM4	UFXLULUK2	UFXLULUK2
Ultra Low Loss (ULL) LazrSPEED 550 WideBand OM5 LC Uniboot to LC Uniboot, Fiber Patch Cord, 1.5 mm Duplex, LSZH/Riser	LC-D to LC-D, 1.5 mm diameter, LSZH/Riser	Distribution/XC	OM5	UFVLULUK2	UFVLULUK2
Ultra Low Loss (ULL) TeraSPEED LC Uniboot to LC Uniboot, Fiber Patch Cord, 1.5 mm Duplex, LSZH/Riser	LC-D to LC-D, 1.5 mm diameter, LSZH/Riser	Distribution/XC	OS2	UFGLULUK2	UFGLULUK2
Ultra Low Loss (ULL) LazrSPEED 550 OM4 LC Uniboot to LC Uniboot, Fiber Patch Cord, 2.0 mm Duplex, LSZH/Riser	LC-D to LC-D, 2 mm diameter, LSZH/Riser	Equipment Area	OM4	UFXLULU62	UFXLULU62
Ultra Low Loss (ULL) LazrSPEED 550 WideBand OM5 LC Uniboot to LC Uniboot, Fiber Patch Cord, 2.0 mm Duplex, LSZH/Riser	LC-D to LC-D, 2 mm diameter, LSZH/Riser	Equipment Area	OM5	UFVLULU62	UFVLULU62
Ultra Low Loss (ULL) TeraSPEED LC Uniboot to LC Uniboot, Fiber Patch Cord, 2.0 mm Duplex, LSZH/Riser	LC-D to LC-D, 2 mm diameter, LSZH/Riser	Equipment Area	OS2	UFGLULU62	UFGLULU62
Ultra Low Loss (ULL) LazrSPEED 550 OM4 MPO/8 (Unpinned) to MPO/8 (Unpinned), 8-Fiber, LSZH/Riser	MPO-MPO, unpinned, 8 fibers, LSZH/Riser	Distribution or Equipment Area	OM4	URXQPQPJ8	URXQPQPJ8
Ultra Low Loss (ULL) LazrSPEED 550 WideBand OM5 MPO/8 (Unpinned) to MPO/8 (Unpinned), 8-Fiber, LSZH/Riser	MPO-MPO, unpinned, 8 fibers, LSZH/Riser	Distribution or Equipment Area	OM5	URVQPQPJ8	URVQPQPJ8
Ultra Low Loss (ULL) TeraSPEED MPO/8 (Unpinned) to MPO/8 (Unpinned), 8-Fiber, LSZH/Riser	MPO-MPO, unpinned, 8 fibers, LSZH/Riser	Distribution or Equipment Area	OS2	URGQPQPJ8	URGQPQPJ8

Direct System Selection Index

BUDI	FACT ODF	UMSC	Flex Frame ODF, 19-in. Propel	FOSC 600	19-in. Splice	Rollable Ribbon Fiber	Other Products	Pre-term 19-in. Fiber	Pre-term FACT ODF Fiber	FiberGuide	Cable Mgmt Wire Baskets	Category 6A	Powered Fiber	DIN Rail	Fiber Wall Boxes	2 Post Equipment	imVision
------	----------	------	-------------------------------	----------	---------------	-----------------------	----------------	-----------------------	-------------------------	------------	-------------------------	-------------	---------------	----------	------------------	------------------	----------

Architecture System Selection Index

Colocation Campus and Building Infrastructure						Customer Space Cabling Infrastructure					Reference Designs and Technical Information						
Fiber Entrance, Meet-Me Room	High Fiber Count DC Interconnect	Campus Cabling	Building Cabling	IDF to Customer Cage (FACT ODF)	IDF to Customer Cage (19-in. Cabinet)	Campus Cabling for Wi-Fi and Security	MDA Fiber	EDA Fiber	EDA Copper	FiberGuide	MDA Cabinet	MDA Cross-connect 19-in.	MDA Cross-connect FACT ODF	IDF FACT	IDF 19-in.		



Review Pre-terminated 19-in. Fiber System Selection here.

All cable assemblies on this page fit to: **Propel**



Propel MPO-12 Singlemode & Multimode Patch Cords

1	2	3	4	5	6	7	8	9	10	11	12	13	14-16
U	Q	X	M	P	M	P	U	D	-	M	A	F	003
Construction type U Ultra-low loss	Cable family Q Plenum Array R Dual Rated (OFNR/LSZH)	Fiber type G Singlemode (A2) X OM4 multimode V OM5 WB multimode	Connector 1 MP 12f MPO (Non-pinned)	Connector 2 MP 12f MPO (Non-pinned)	Cordage size U 12f PmP Array Cord, 2mm		Fiber count D 12-fiber	Color M OM4 Aqua N OM5 Lime green J Yellow		Breakout length A No gland	UOM F Feet M Meter	Length 010-999 ft 003-305 m	



Propel MPO-12 Singlemode & Multimode Patch Cords

1	2	3	4	5	6	7	8	9	10	11	12	13	14-16
U	Q	G	M	P	L	U	U	D	-	M	D	F	003
Construction type U Ultra-low loss	Cable family Q Plenum Array R Dual Rated (OFNR/LSZH)	Fiber type G Singlemode (A2) X OM4 multimode V OM5 WB multimode	Connector 1 MP 12f MPO (Non-pinned)	Connector 2 LU LC Uniboot	Cordage size U 12f PmP Array Cord, 2mm		Fiber count D 12-fiber	Color M OM4 Aqua N OM5 Lime green		Breakout length D 12" E 24" H 48" L 72"	UOM F Feet M Meter	Length 12 in 3-999 ft 24 in 4-999 ft 48 in 6-999 ft 72 in 8-999 ft 12 in 1-305 m 24-48 in 2-305 m 72 in 3-305 m	

Fiber Cleaning	Part Number
Fiber Optic MTP/MPO One Slot Reel Cleaner	1918802-1
One slot reel cleaner for 1.25 mm and 2.5 mm ferrule connectors, MPO/MTP without pins (female), and MT-RJ without pins (female)	1918803-1
Fiber Optic MTP/MPO IBC (In Bulkhead Cleaner)	1918809-1
Fiber Optic SC IBC (In Bulkhead Cleaner)	2064499-1
Fiber Optic LC IBC (In Bulkhead Cleaner)	2064500-1
Cleaning and Inspection Kit, Fiber Optic	760053199
Cleaning Consumables Kit, Fiber Optic	760053207



Fiber Optic Cleaning and Inspection Kit

Note: For MPO-8, MPO-16, and MPO-24 products and other trunk configurations please contact your CommScope sales representative.

Direct System Selection Index

BUDI	FACT ODF	UMSC	Flex Frame ODF, 19-in. Propel	FOSC 600	19-in. Splice	Rollable Ribbon Fiber	Other Products	Pre-term 19-in. Fiber	Pre-term FACT ODF Fiber	FiberGuide	Cable Mgmt Wire Baskets	Category 6A	Powered Fiber	DIN Rail	Fiber Wall Boxes	2 Post Equipment	imVision
------	----------	------	-------------------------------	----------	---------------	-----------------------	----------------	-----------------------	-------------------------	------------	-------------------------	-------------	---------------	----------	------------------	------------------	----------

Architecture System Selection Index

Colocation Campus and Building Infrastructure						Customer Space Cabling Infrastructure					Reference Designs and Technical Information						
Fiber Entrance, Meet-Me Room	High Fiber Count DC Interconnect	Campus Cabling	Building Cabling	IDF to Customer Cage (FACT ODF)	IDF to Customer Cage (19-in. Cabinet)	Campus Cabling for Wi-Fi and Security	MDA Fiber	EDA Fiber	EDA Copper	FiberGuide	MDA Cabinet	MDA Cross-connect 19-in.	MDA Cross-connect FACT ODF	IDF FACT	IDF 19-in.		

Select a product for more information.

FACT-FACT Pre-Term



FACT Cross Connect Frame

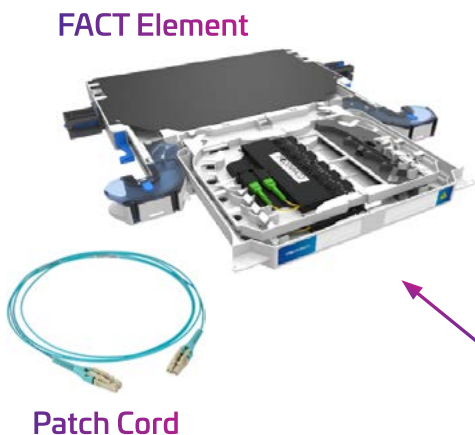

FACT Element

Patch Cord



MPO Trunk or Array Trunk



FACT ULL Module



FACT Element



Patch Cord



FACT Cross Connect Frame

FACT-Panel Pre-Term



FACT Cross Connect Frame

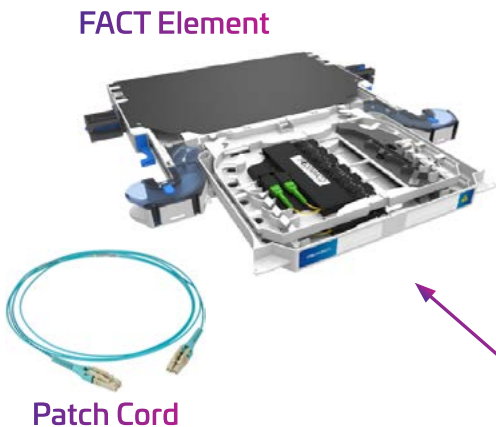

FACT Element

Patch Cord



MPO Trunk or Array Trunk



FACT ULL Module



Fiber Basic



Fiber HD



Propel



Mixed Media Basic

Direct System Selection Index

BUDI	FACT ODF	UMSC	Flex Frame ODF, 19-in. Propel	FOSC 600	19-in. Splice	Rollable Ribbon Fiber	Other Products	Pre-term 19-in. Fiber	Pre-term FACT ODF Fiber	FiberGuide	Cable Mgmt Wire Baskets	Category 6A	Powered Fiber	DIN Rail	Fiber Wall Boxes	2 Post Equipment	imVision
------	----------	------	-------------------------------	----------	---------------	-----------------------	----------------	-----------------------	-------------------------	------------	-------------------------	-------------	---------------	----------	------------------	------------------	----------

Architecture System Selection Index

Colocation Campus and Building Infrastructure

Fiber Entrance, Meet-Me Room	High Fiber Count DC Interconnect	Campus Cabling	Building Cabling	IDF to Customer Cage (FACT ODF)	IDF to Customer Cage (19-in. Cabinet)
------------------------------	----------------------------------	----------------	------------------	---------------------------------	---------------------------------------

Customer Space Cabling Infrastructure

Campus Cabling for Wi-Fi and Security	MDA Fiber	EDA Fiber	EDA Copper	FiberGuide
---------------------------------------	-----------	-----------	------------	------------

Reference Designs and Technical Information

MDA Cabinet	MDA Cross-connect 19-in.	MDA Cross-connect FACT ODF	IDF FACT	IDF 19-in.
-------------	--------------------------	----------------------------	----------	------------



Review Pre-terminated FACT ODF Fiber System Selection here.

FACT Frame		Description Code	Part Number		
FACT Cross Connect frame, patching on the right		FACT-FRCCRHP22	760243095		
FACT Cross Connect frame, patching on the Left		FACT-FRCLHP22	760243094		
FACT patch cord overlength management bay		FACT-FROLB22	760243097		
FACT Interconnect Frame – Right Hand Patch (2.2m)		FACT-FRICRHP22	760243096		
FACT Frame Accessories		Description Code	Part Number		
FACT Cross Connect door kit. Set of two doors with two door handles per door (one set per frame)		FACT-FRCCD22	760243098		
FACT Cross Connect side panel kit (pack of two side panels)		FACT-FRCCP22	760243099		
FACT Patch Cord Overlength Bay Door (2.2m)		FACT-FROLBD22	760243101		
FACT Interconnect Frame door kit		FACT-FRICD22	760243100		
FACT Fiber guide fixation kit		FACT-FRACCFGFS	760243110		
FACT-FRACCCAPL One cable attachment plate with one cable to flex conversion bracket included.		FACT-FRACCCAPL	760243108		
FACT-FRACCCTF One cable to flex conversion component set for cable attachment plate (one cable to flex component per cable)		FACT-FRACCCTF	760243111		
FACT-FRACCFOPL One fan out fixation plate for frame side duct & Eight fan out fixation component sets		FACT-FRACCFOPL	760243109		
Eight fan out fixation component sets (for fan out fixation plate) FACT		FACT-FRACCFOFK-8	760243112		
FACT Patch-Patch Elements and FACT NG4 Elements	Element Type	Fiber Count	Fiber Type	Description Code	Part Number
FACT Fiber Optic Patch Panel, blue, 6E high, 288-port simplex, multimode, OM4, holding 10 hinged trays loaded with LC/UPC adapters	Patch/Patch	288	OM4	FACT-6EPATL4	760240442
FACT Fiber Optic Patch Panel, blue, 6E high, 288-port simplex, singlemode, holding 10 hinged trays loaded with LC/UPC adapters	Patch/Patch	288	OS2	FACT-6EPATL1	760240441
FACT Fiber Optic Patch Panel, blue, 4E high, 192-port simplex, multimode, OM4, holding 8 hinged trays loaded with LC/UPC adapters	Patch/Patch	192	OM4	FACT-4EPATL4	760239995
FACT Fiber Optic Patch Panel, blue, 4E high, 192-port simplex, singlemode, holding 8 hinged trays loaded with LC/UPC adapters	Patch/Patch	192	OS2	FACT-4EPATL1	760239993
FACT Fiber Optic Patch Panel, blue, 3E high, 144-port simplex, multimode, OM4, holding 6 hinged trays loaded with LC/UPC adapters	Patch/Patch	144	OM4	FACT-3EPATL4	760239990
FACT Fiber Optic Patch Panel, blue, 3E high, 144-port simplex, singlemode, holding 6 hinged trays loaded with LC/UPC adapters	Patch/Patch	144	OS2	FACT-3EPATL1	760239988
FACT Fiber Optic Patch Panel, blue, 2E high, 96-port simplex, multimode, OM4, holding 4 hinged trays loaded with LC/UPC adapters	Patch/Patch	96	OM4	FACT-2EPATL4	760239984
FACT Fiber Optic Patch Panel, blue, 2E high, 96-port simplex, singlemode, holding 4 hinged trays loaded with LC/UPC adapters	Patch/Patch	96	OS2	FACT-2EPATL1	760239982
FACT Fiber Optic Patch Panel, blue, 1E high, 48-port simplex, multimode, OM4, holding 2 hinged trays loaded with LC/UPC adapters	Patch/Patch	48	OM4	FACT-1EPATL4	760240416
FACT Fiber Optic Patch Panel, blue, 1E high, 48-port simplex, singlemode, holding 2 hinged trays loaded with LC/UPC adapters	Patch/Patch	48	OS2	FACT-1EPATL1	760240414
FACT NG4 Fiber Panel, with 12 unloaded trays, blue, 6E high, for holding 12 NG4 MPO modules	NG4 Module	288	Universal	FACT-6ENG4	760242087
FACT NG4 Fiber Panel, with 8 unloaded trays, blue, 4E high, for holding 8 NG4 MPO modules	NG4 Module	192	Universal	FACT-4ENG4	760239978
FACT NG4 Fiber Panel, with 6 unloaded trays, blue, 3E high, for holding 6 NG4 MPO modules	NG4 Module	144	Universal	FACT-3ENG4	760239977
FACT NG4 Fiber Panel, with 4 unloaded trays, blue, 2E high, for holding 4 NG4 MPO modules	NG4 Module	96	Universal	FACT-2ENG4	760239976
FACT NG4 Fiber Panel, with 2 unloaded trays, blue, 1E high, for holding 2 NG4 MPO modules	NG4 Module	48	Universal	FACT-1ENG4	760239975
FACT NG4 Module	Cable Entrance	Fiber Type	Description Code		
FACT left sided ULL module, MPO24f to 12x LC-D, OM4	Left	OM4	FACT-MMDLC2-B		
FACT right sided ULL module, MPO24f to 12x LC-D, OM4	Right	OM4	FACT-MMDRC2-B		
FACT left sided ULL module, MPO24f to 12x LC-D, OM5	Left	OM5	FACT-MMDL52-B		
FACT right sided ULL module, MPO24f to 12x LC-D, OM5	Right	OM5	FACT-MMDR52-B		
FACT left sided ULL module, 2 x MPO12f to 12x LC-D, OS2	Left	OS2	FACT-MMDLKE-B		
FACT right sided ULL module, 2 x MPO12f to 12x LC-D, OS2	Right	OS2	FACT-MMDRKE-B		

Direct System Selection Index

BUDI	FACT ODF	UMSC	Flex Frame ODF, 19-in. Propel	FOSC 600	19-in. Splice	Rollable Ribbon Fiber	Other Products	Pre-term 19-in. Fiber	Pre-term FACT ODF Fiber	FiberGuide	Cable Mgmt Wire Baskets	Category 6A	Powered Fiber	DIN Rail	Fiber Wall Boxes	2 Post Equipment	imVision
------	----------	------	-------------------------------	----------	---------------	-----------------------	----------------	-----------------------	-------------------------	------------	-------------------------	-------------	---------------	----------	------------------	------------------	----------

Architecture System Selection Index

Colocation Campus and Building Infrastructure

Fiber Entrance, Meet-Me Room	High Fiber Count DC Interconnect	Campus Cabling	Building Cabling	IDF to Customer Cage (FACT ODF)	IDF to Customer Cage (19-in. Cabinet)	Campus Cabling for Wi-Fi and Security
------------------------------	----------------------------------	----------------	------------------	---------------------------------	---------------------------------------	---------------------------------------

Customer Space Cabling Infrastructure

MDA Fiber	EDA Fiber	EDA Copper	FiberGuide
-----------	-----------	------------	------------

Reference Designs and Technical Information

MDA Cabinet	MDA Cross-connect 19-in.	MDA Cross-connect FACT ODF	IDF FACT	IDF 19-in.
-------------	--------------------------	----------------------------	----------	------------



Review Pre-terminated FACT ODF Fiber System Selection here.

All cable assemblies on this page fit to:

FACT-FACT Pre-Term

FACT-Panel Pre-Term

SYSTIMAX ULL Pre-terminated Trunk Cables

12-fiber MPO connector-based modules available in LazrSPEED 550 OM4 and LazrSPEED OM5 Wideband multimode fiber solutions

12-fiber MPO connector-based modules available in TeraSPEED singlemode fiber solutions

Factory-terminated and tested trunk cables provide superior quality and performance for field connections

Reliable transmit-to-receive connectivity using Method B Enhanced polarity maintenance maximizes administrative convenience

Simplified reconfiguration for moves, adds and changes (MACs)

Easy upgrade path to parallel transmission and associated applications, and increased value of existing infrastructure

SYSTIMAX ULL trunks are provisioned with pins to interface with G2 and Propel ULL modules (without pins)



SYSTIMAX ULL MPO-12 Trunk Cables

1 U	2 3	3 X	4 5 M X	6 7 M X	8 A	9 10 11 K - M	12 A	13 F	14-16 010	
Construction type U Ultra-Low Loss	Family 3 Trunk, LSZH/Riser, CPR Class B2ca 6 Trunk, LSZH/Riser, CPR Class Dca	Fiber type G TeraSPEED singlemode (A2) X LazrSPEED 550 multimode V LazrSPEED OM5 WB multimode	Termination end A MX MPO (pinned)	Termination end B MX MPO (pinned)	Construction A 12 Fiber PmP	Fiber count D 12-fiber F 24-fiber H 48-fiber K 72-fiber L 96-fiber M 144-fiber	Color M Aqua N Lime green J Yellow LazrSPEED OM4 standard is aqua LazrSPEED OM5 standard is lime green TeraSPEED singlemode standard is yellow	Options W No gland, 60-in. breakout Use accessory gland for patch cords in case gland is required on one side only	Unit of measure F Feet M Meter	Length 010-999 Feet 003-305 Meter

Note: for MPO-8 products and other trunk configurations please contact your CommScope sales representative.

Direct System Selection Index

BUDI	FACT ODF	UMSC	Flex Frame ODF, 19-in. Propel	FOSC 600	19-in. Splice	Rollable Ribbon Fiber	Other Products	Pre-term 19-in. Fiber	Pre-term FACT ODF Fiber	FiberGuide	Cable Mgmt Wire Baskets	Category 6A	Powered Fiber	DIN Rail	Fiber Wall Boxes	2 Post Equipment	imVision
------	----------	------	-------------------------------	----------	---------------	-----------------------	----------------	-----------------------	-------------------------	------------	-------------------------	-------------	---------------	----------	------------------	------------------	----------

Architecture System Selection Index

Colocation Campus and Building Infrastructure

Fiber Entrance, Meet-Me Room	High Fiber Count DC Interconnect	Campus Cabling	Building Cabling	IDF to Customer Cage (FACT ODF)	IDF to Customer Cage (19-in. Cabinet)	Campus Cabling for Wi-Fi and Security	MDA Fiber	EDA Fiber	EDA Copper	FiberGuide	MDA Cabinet	MDA Cross-connect 19-in.	MDA Cross-connect FACT ODF	IDF FACT	IDF 19-in.
------------------------------	----------------------------------	----------------	------------------	---------------------------------	---------------------------------------	---------------------------------------	-----------	-----------	------------	------------	-------------	--------------------------	----------------------------	----------	------------

Customer Space Cabling Infrastructure

Reference Designs and Technical Information



Review Pre-terminated FACT ODF Fiber System Selection here.

All cable assemblies on this page fit to:

FACT-FACT Pre-Term

FACT-Panel Pre-Term



SYSTIMAX ULL MPO Array Cords

SYSTIMAX ULL MPO Array Cords

12-fiber MPO connector-based modular design enables simple connections

Array cords are constructed with 550 OM4 and OM5 Wideband and singlemode fibers

Factory-terminated and tested for instant field connections giving guaranteed quality and performance

MPO-MPO arrays are constructed with 3.0 mm PmP array cords

1 U	2 O	3 X	4 M	5 X	6 M	7 X	8 G	9 D	10 -	11 M	12 E	13 F	14-16 010
Construction type U Ultra-Low Loss	Cable family R LSZH array	Fiber type G TeraSPEED singlemode (A2) X LazrSPEED 550 multimode V LazrSPEED OM5 WB multimode	Connector 1 MX 12f MPO (pinned)	Connector 2 MX 12f MPO (pinned)	Cordage size G 12-fiber PmP Array Cord	Fiber count D 12-fiber	Color M Aqua N Lime green J Yellow LazrSPEED OM4 standard is aqua LazrSPEED OM5 standard is lime green TeraSPEED singlemode standard is yellow	Breakout length D 12 in breakout, no gland E 24 in breakout, no gland H 48 in breakout, no gland L 72 in breakout, no gland P 96 in breakout, no gland A No gland, no breakout	Unit of measure F Feet M Meter	Length minimal length based on breakout 12 in 3-999 ft 24 in 4-999 ft 48 in 6-999 ft 72 in 8-999 ft 96 in 10-999 ft 12 in 1-305 m 24-48 in 2-305 m 72 in 3-305 m 96 in 4-305 m Total length includes the breakout			

Note: for MPO-8 products and other trunk configurations please contact your CommScope sales representative.

Direct System Selection Index

BUDI	FACT ODF	UMSC	Flex Frame ODF, 19-in. Propel	FOSC 600	19-in. Splice	Rollable Ribbon Fiber	Other Products	Pre-term 19-in. Fiber	Pre-term FACT ODF Fiber	FiberGuide	Cable Mgmt Wire Baskets	Category 6A	Powered Fiber	DIN Rail	Fiber Wall Boxes	2 Post Equipment	imVision
------	----------	------	-------------------------------	----------	---------------	-----------------------	----------------	-----------------------	-------------------------	------------	-------------------------	-------------	---------------	----------	------------------	------------------	----------

Architecture System Selection Index

Colocation Campus and Building Infrastructure

Fiber Entrance, Meet-Me Room	High Fiber Count DC Interconnect	Campus Cabling	Building Cabling	IDF to Customer Cage (FACT ODF)	IDF to Customer Cage (19-in. Cabinet)	Campus Cabling for Wi-Fi and Security	MDA Fiber	EDA Fiber	EDA Copper	FiberGuide	MDA Cabinet	MDA Cross-connect 19-in.	MDA Cross-connect FACT ODF	IDF FACT	IDF 19-in.
------------------------------	----------------------------------	----------------	------------------	---------------------------------	---------------------------------------	---------------------------------------	-----------	-----------	------------	------------	-------------	--------------------------	----------------------------	----------	------------

Customer Space Cabling Infrastructure

Reference Designs and Technical Information



Review Pre-terminated FACT ODF Fiber System Selection here.



SYSTIMAX ULL LC-LC Pre-terminated Array Trunks

LC/LC trunks, 24 f	Patch Cord Type	Jacket Material	Fiber Type	Description Code	Part Number
LC/LC Microdistribution-cable, 12 x LC Duplex uniboot on each side, flexible cable construction, OD 3 mm	N/A	LSZH/Riser	OM4	URXLULUHF	URXLULUHF
LC/LC Microdistribution-cable, 12 x LC Duplex uniboot on each side, flexible cable construction, OD 3 mm	N/A	LSZH/Riser	OM5	URVLULUHF	URVLULUHF
LC/LC Microdistribution-cable, 12 x LC Duplex uniboot on each side, flexible cable construction, OD 3 mm	N/A	LSZH/Riser	OS2	FRWLULUHF	FRWLULUHF

SYSTIMAX ULL Patch Cords

Patch Cords	Patch Cord Type	Application	Fiber Type	Description Code	Part Number
Ultra Low Loss (ULL) LazrSPEED 550 OM4 LC Uniboot to LC Uniboot, Fiber Patch Cord, 1.5 mm Duplex, LSZH/Riser	LC-D to LC-D, 1.5 mm diameter, LSZH/Riser	Distribution/XC	OM4	UFXLULUK2	UFXLULUK2
Ultra Low Loss (ULL) LazrSPEED 550 WideBand OM5 LC Uniboot to LC Uniboot, Fiber Patch Cord, 1.5 mm Duplex, LSZH/Riser	LC-D to LC-D, 1.5 mm diameter, LSZH/Riser	Distribution/XC	OM5	UFVLULUK2	UFVLULUK2
Ultra Low Loss (ULL) TeraSPEED LC Uniboot to LC Uniboot, Fiber Patch Cord, 1.5 mm Duplex, LSZH/Riser	LC-D to LC-D, 1.5 mm diameter, LSZH/Riser	Distribution/XC	OS2	UFGLULUK2	UFGLULUK2
Ultra Low Loss (ULL) LazrSPEED 550 OM4 LC Uniboot to LC Uniboot, Fiber Patch Cord, 2.0 mm Duplex, LSZH/Riser	LC-D to LC-D, 2 mm diameter, LSZH/Riser	Equipment Area	OM4	UFXLULU62	UFXLULU62
Ultra Low Loss (ULL) LazrSPEED 550 WideBand OM5 LC Uniboot to LC Uniboot, Fiber Patch Cord, 2.0 mm Duplex, LSZH/Riser	LC-D to LC-D, 2 mm diameter, LSZH/Riser	Equipment Area	OM5	UFVLULU62	UFVLULU62
Ultra Low Loss (ULL) TeraSPEED LC Uniboot to LC Uniboot, Fiber Patch Cord, 2.0 mm Duplex, LSZH/Riser	LC-D to LC-D, 2 mm diameter, LSZH/Riser	Equipment Area	OS2	UFGLULU62	UFGLULU62
Ultra Low Loss (ULL) LazrSPEED 550 OM4 MPO/8 (Unpinned) to MPO/8 (Unpinned), 8-Fiber, LSZH/Riser	MPO-MPO, unpinned, 8 fibers, LSZH/Riser	Distribution or Equipment Area	OM4	URXQPQPJ8	URXQPQPJ8
Ultra Low Loss (ULL) LazrSPEED 550 WideBand OM5 MPO/8 (Unpinned) to MPO/8 (Unpinned), 8-Fiber, LSZH/Riser	MPO-MPO, unpinned, 8 fibers, LSZH/Riser	Distribution or Equipment Area	OM5	URVQPQPJ8	URVQPQPJ8
Ultra Low Loss (ULL) TeraSPEED MPO/8 (Unpinned) to MPO/8 (Unpinned), 8-Fiber, LSZH/Riser	MPO-MPO, unpinned, 8 fibers, LSZH/Riser	Distribution or Equipment Area	OS2	URGQPQPJ8	URGQPQPJ8

Direct System Selection Index

BUDI	FACT ODF	UMSC	Flex Frame ODF, 19-in. Propel	FOSC 600	19-in. Splice	Rollable Ribbon Fiber	Other Products	Pre-term 19-in. Fiber	Pre-term FACT ODF Fiber	FiberGuide	Cable Mgmt Wire Baskets	Category 6A	Powered Fiber	DIN Rail	Fiber Wall Boxes	2 Post Equipment	imVision
------	----------	------	-------------------------------	----------	---------------	-----------------------	----------------	-----------------------	-------------------------	------------	-------------------------	-------------	---------------	----------	------------------	------------------	----------

Architecture System Selection Index

Colocation Campus and Building Infrastructure						Customer Space Cabling Infrastructure					Reference Designs and Technical Information						
Fiber Entrance, Meet-Me Room	High Fiber Count DC Interconnect	Campus Cabling	Building Cabling	IDF to Customer Cage (FACT ODF)	IDF to Customer Cage (19-in. Cabinet)	Campus Cabling for Wi-Fi and Security	MDA Fiber	EDA Fiber	EDA Copper	FiberGuide	MDA Cabinet	MDA Cross-connect 19-in.	MDA Cross-connect FACT ODF	IDF FACT	IDF 19-in.		



FiberGuide[®] Raceway Systems



FiberGuide is a raceway system designed to protect and route fiber optic patch cords to and from fiber splice enclosures, fiber distribution frames, and fiber optic terminal devices. FiberGuide ensures a 2-in. minimum bend radius is maintained throughout the system. Tool-less, Snap-Fit® junctions, cover options, and Plenum Express Exit® drops significantly reduce the amount of time required for installation.

The FiberGuide system is a complete set of products designed and manufactured to ensure total off-frame protection and ease of use. Basic components include horizontal and vertical straight sections, horizontal and vertical elbows, downspouts, junctions, and numerous support hardware and flex-tube kits.

Speed of installation

FiberGuide systems feature a variety of products that allow for quick and easy installation. Express Exit drops as well as tool-less products including Snap-Fit junctions, snap-on covers and new-hinged cover options save valuable time for installers.

Speed of deployment

The Express Exit system enables new drops to be added or removed quickly and easily. A drop can be added into a fully loaded raceway in seconds—without cutting.

Raceway flexibility

FiberGuide features 38 support structures, over 75 fittings, multiple drop options, and several other components to suit any application you create.

Fiber protection

Our broadband expertise translates into maximum protection for your network. 2-in. minimum bend radius is maintained throughout the system regardless of the raceway size.

Strength and durability

One-hundred percent raceway reliability—stands up to any challenge.

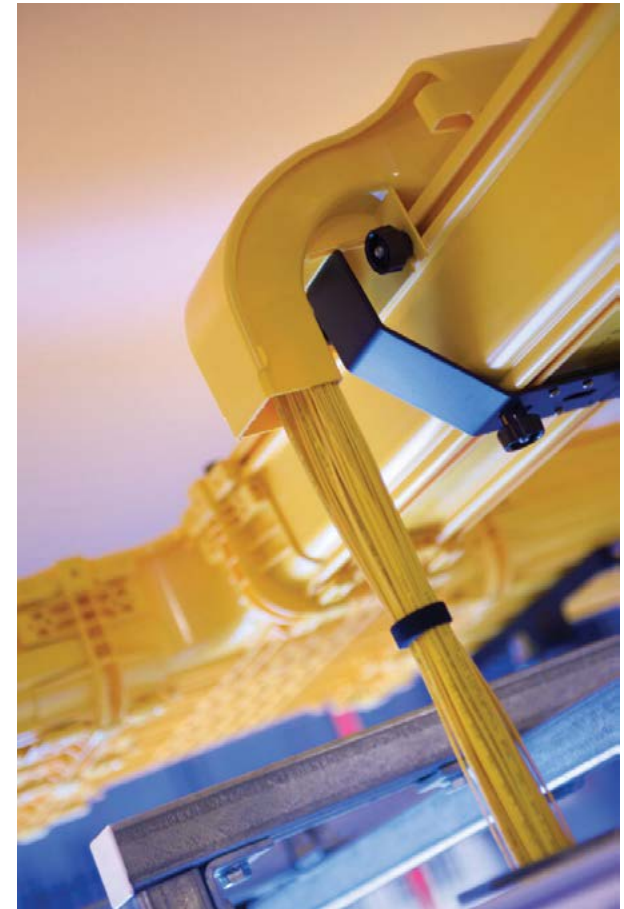

Direct System Selection Index

BUDI	FACT ODF	UMSC	Flex Frame ODF, 19-in. Propel	FOSC 600	19-in. Splice	Rollable Ribbon Fiber	Other Products	Pre-term 19-in. Fiber	Pre-term FACT ODF Fiber	FiberGuide	Cable Mgmt Wire Baskets	Category 6A	Powered Fiber	DIN Rail	Fiber Wall Boxes	2 Post Equipment	imVision
------	----------	------	-------------------------------	----------	---------------	-----------------------	----------------	-----------------------	-------------------------	------------	-------------------------	-------------	---------------	----------	------------------	------------------	----------

Architecture System Selection Index

Colocation Campus and Building Infrastructure						Customer Space Cabling Infrastructure					Reference Designs and Technical Information						
Fiber Entrance, Meet-Me Room	High Fiber Count DC Interconnect	Campus Cabling	Building Cabling	IDF to Customer Cage (FACT ODF)	IDF to Customer Cage (19-in. Cabinet)	Campus Cabling for Wi-Fi and Security	MDA Fiber	EDA Fiber	EDA Copper	FiberGuide	MDA Cabinet	MDA Cross-connect 19-in.	MDA Cross-connect FACT ODF	IDF FACT	IDF 19-in.		







Review additional FiberGuide products here.





4-in. x 6-in. FiberGuide System

Description	Part Number	
4x6 Horizontal Straight Section, 6-ft. long, yellow	FGS-MSHS-B	
4x6 Horizontal Stack Storage Section, yellow	FGS-MSHS-STOR-B	
4x6 Horizontal T, yellow	FGS-MHRT-B	
4x6 Horizontal Cross, yellow	FGS-MHXP-B	
4x6 Horizontal Elbow 90°, yellow	FGS-MH9E-B	
4x6 Down Spout, yellow	FGS-MDSP-B	
4x6 Trumpet Flare, yellow	FGS-MTRM-B	
4x6 Down Elbow 45°, yellow	FGS-MD4E-B	
4x6 Up Elbow 45°, yellow	FGS-MU4E-B	
4x6 Junction	FGS-MFAW-B	
4x6 End Cap, black	FGS-HMEC-B	

4-in. x 6-in. Supports

Description	Part Number	
L Bay Support Bracket	FGS-HLBK	
Center Support Bracket Kit (xx = size: 1/2-in., 5/8-in., 12 mm, 14 mm, 16 mm)	FGS-HTUB	
Top Support C-Bracket Kit (xx = size: 1/2-in., 5/8-in., 12 mm, 14 mm, 16 mm)	FGS-HNTS	
Unistrut Kit; 10 Quick Knob T-Bolt	FGS-ACC532	

Express Exits

Description	Part Number	
4-in. Express Exit with 4x4 exit opening, yellow	FGS-MEXP-E-A/B/F	
2-in. Low Profile Express Exit with 2x2 exit opening, yellow	FGS-MEXP-LP-A/B/F	
2x2 Trumpet Flare for 2-in. Express Exits, yellow	FGS-MTRM-C	
Single 2-in. Flex Tube Attachment 2-in. flex tube and 2x2 junction to attach to Express Exit		
5-ft. length	FGS-MEXI-C-5F	
10-ft. length	FGS-MEXI-C-10F	
15-ft. length	FGS-MEXI-C-15F	

Direct System Selection Index

BUDI	FACT ODF	UMSC	Flex Frame ODF, 19-in. Propel	FOSC 600	19-in. Splice	Rollable Ribbon Fiber	Other Products	Pre-term 19-in. Fiber	Pre-term FACT ODF Fiber	FiberGuide	Cable Mgmt Wire Baskets	Category 6A	Powered Fiber	DIN Rail	Fiber Wall Boxes	2 Post Equipment	imVision
------	----------	------	-------------------------------	----------	---------------	-----------------------	----------------	-----------------------	-------------------------	------------	-------------------------	-------------	---------------	----------	------------------	------------------	----------

Architecture System Selection Index

Colocation Campus and Building Infrastructure

Fiber Entrance, Meet-Me Room	High Fiber Count DC Interconnect	Campus Cabling	Building Cabling	IDF to Customer Cage (FACT ODF)	IDF to Customer Cage (19-in. Cabinet)	Campus Cabling for Wi-Fi and Security
------------------------------	----------------------------------	----------------	------------------	---------------------------------	---------------------------------------	---------------------------------------

Customer Space Cabling Infrastructure

MDA Fiber	EDA Fiber	EDA Copper	FiberGuide
-----------	-----------	------------	------------

Reference Designs and Technical Information

MDA Cabinet	MDA Cross-connect 19-in.	MDA Cross-connect FACT ODF	IDF FACT	IDF 19-in.
-------------	--------------------------	----------------------------	----------	------------



Review additional FiberGuide products here.

4-in. x 12-in. FiberGuide System

Description	Part Number	
4x12 Horizontal Straight Section, 6-ft. long, yellow	FGS-MSHS-F	
4x12 Horizontal Slack Storage Section, yellow	FGS-MSHS-STOR-F	
4x12 Horizontal T, yellow	FGS-MHRT-F	
4x12 Horizontal Cross, yellow	FGS-MHXP-F	
4x12 Horizontal Elbow 90°, yellow	FGS-MH9E-F	
4x12 Down Spout, yellow	FGS-MDSP-F	
4x12 Trumpet Flare, yellow	FGS-MTRM-F	
4x12 Horizontal Cross with two 6-in. exit, yellow	FGS-MHXP-B/F	
4x12 Down Elbow 45°, yellow	FGS-MD4E-F	
4x12 Up Elbow 45°, yellow	FGS-MU4E-F	
4x12 Junction	FGS-MFAW-F	
4x12 End Cap	FGS-HMEC-F	
Trapeze Bracket Kit (xx = size: 1/2-in., 5/8-in., 12 mm, 14 mm, 16 mm)	FGS-HNTP-F-XX	

4-in. x 24-in. FiberGuide System

Description	Part Number	
4x24 Horizontal Straight Section, 6-in. long, yellow	FGS-MSHS-H	
4x24 Horizontal T, with single 12-in. exit, yellow	FGS-MHRT-H/F	
4x24 Horizontal T with three 24-in. exits, yellow	FGS-MHRT-H	
4x24 Horizontal Cross, yellow	FGS-MHXP-H	
4x24 Horizontal Cross with dual 12-in. exits	FGS-MHXP-F/H	
4x24 Horizontal Elbow 45°, yellow	FGS-MH4E-H	
4x24 Down Elbow 45°, yellow	FGS-MD4E-H	
4x24 Up Elbow 45°, yellow	FGS-MU4E-H	
4x24 Junction	FGS-MFAW-H	
4x24 End Cap	FGS-HMEC-H	
Threaded Rod Trapeze Bracket Kit for New, 5/8-in.	FGS-HNTP-H-5/8	

Direct System Selection Index

BUDI	FACT ODF	UMSC	Flex Frame ODF, 19-in. Propel	FOSC 600	19-in. Splice	Rollable Ribbon Fiber	Other Products	Pre-term 19-in. Fiber	Pre-term FACT ODF Fiber	FiberGuide	Cable Mgmt Wire Baskets	Category 6A	Powered Fiber	DIN Rail	Fiber Wall Boxes	2 Post Equipment	imVision
------	----------	------	-------------------------------	----------	---------------	-----------------------	----------------	-----------------------	-------------------------	------------	-------------------------	-------------	---------------	----------	------------------	------------------	----------

Architecture System Selection Index

Colocation Campus and Building Infrastructure

Fiber Entrance, Meet-Me Room	High Fiber Count DC Interconnect	Campus Cabling	Building Cabling	IDF to Customer Cage (FACT ODF)	IDF to Customer Cage (19-in. Cabinet)	Campus Cabling for Wi-Fi and Security
------------------------------	----------------------------------	----------------	------------------	---------------------------------	---------------------------------------	---------------------------------------

Customer Space Cabling Infrastructure

MDA Fiber	EDA Fiber	EDA Copper	FiberGuide
-----------	-----------	------------	------------

Reference Designs and Technical Information

MDA Cabinet	MDA Cross-connect 19-in.	MDA Cross-connect FACT ODF	IDF FACT	IDF 19-in.
-------------	--------------------------	----------------------------	----------	------------



Cable Management Wire Baskets



CommScope also offers a cable management wire basket (CMWB) solution to support copper cable infrastructure.

The CommScope CMWB solution is a state-of-the-art offering that meets all the challenges of carrying data communication cables while maintaining the stringent requirements recommended by the latest cabling standards of TIA 568C. It can support cabling for Cat5e/Cat6/Cat6A/Cat7/Cat7a while ensuring the bend radius requirements are met all along the lay of the cable. This ensures that you get the best performance from your channel and ensures longevity of your structured cabling products.

The solution uses high strength steel and goes through a rigorous and closely monitored manufacturing process that ensures the premium quality of the product. The CommScope cable management wire basket solution is elegantly simple to install and easy to fit.

For more information, please contact your local CommScope team.

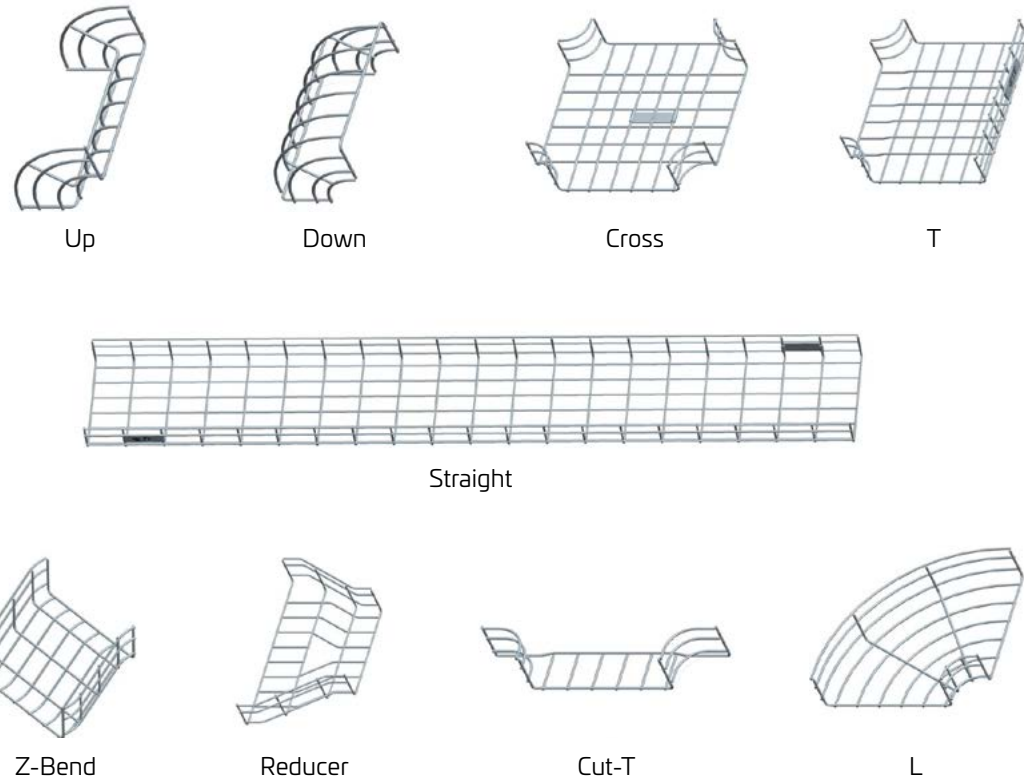

Direct System Selection Index

BUDI	FACT ODF	UMSC	Flex Frame ODF, 19-in. Propel	FOSC 600	19-in. Splice	Rollable Ribbon Fiber	Other Products	Pre-term 19-in. Fiber	Pre-term FACT ODF Fiber	FiberGuide	Cable Mgmt Wire Baskets	Category 6A	Powered Fiber	DIN Rail	Fiber Wall Boxes	2 Post Equipment	imVision
------	----------	------	-------------------------------	----------	---------------	-----------------------	----------------	-----------------------	-------------------------	------------	-------------------------	-------------	---------------	----------	------------------	------------------	----------

Architecture System Selection Index

Colocation Campus and Building Infrastructure

Fiber Entrance, Meet-Me Room	High Fiber Count DC Interconnect	Campus Cabling	Building Cabling	IDF to Customer Cage (FACT ODF)	IDF to Customer Cage (19-in. Cabinet)	Campus Cabling for Wi-Fi and Security	MDA Fiber	EDA Fiber	EDA Copper	FiberGuide	MDA Cabinet	MDA Cross-connect 19-in.	MDA Cross-connect FACT ODF	IDF FACT	IDF 19-in.
------------------------------	----------------------------------	----------------	------------------	---------------------------------	---------------------------------------	---------------------------------------	-----------	-----------	------------	------------	-------------	--------------------------	----------------------------	----------	------------

Customer Space Cabling Infrastructure

Reference Designs and Technical Information



Category 6A Systems



Pre-terminated
Field Installable
Unshielded
Shielded

Evolve U/UTP Panel, Field Installable		Copper Tech	Description Code	Part Number	
	SYSTIMAX GigaSPEED X10D Evolve 1U U/UTP Panel Kit	U/UTP	360-E-MOD-1U-24	760187187	
Evolve Mixed Media Panels		Copper Tech	Description Code	Part Number	
	SYSTIMAX GigaSPEED X10D and GigaSPEED XL Evolve 1U U/UTP Panel Kit	U/UTP	360-E-KIT-1U	760155739	
	SYSTIMAX GigaSPEED X10D Evolve 1U F/UTP Panel Kit	F/UTP	360-IPR-MFTP-E-HD6B-1U-24	760150144	
Evolve Mixed Media Panels Accessories			Description Code	Part Number	
SYSTIMAX 360 1100 Evolve G2 BEZEL (Cool Gray)			360-1100-E-FB-4PK	760175877	
SYSTIMAX 360 1100 Evolve Fiber Cable Management			361 1100-E-FCM	760175919	
SYSTIMAX 360 1100 Evolve G2 BEZEL (Blank)			360-1100-E-BB	760165191	
InstaPATCH Copper Trunks Pre-terminated		Copper Tech	Jacket Material	Description Code	Part Number
	InstaPATCH Cu U/UTP LSZH Pre-terminated Copper Cable, 360 1100 Evolve module to 360 1100 Evolve module, 6 links	U/UTP	LSZH	CCRRB-11SA08	CCRRB-11SA08
	InstaPATCH Cu F/UTP LSZH Copper Cable, single row standard density outlet to single row standard density outlet, 6 links	F/UTP	LSZH	CFAAB-11SA08	CFAAB-11SA08
Field Installable Category 6A Copper Cable		Copper Tech	Jacket Material	Description Code	Part Number
	GigaSPEED X10D 3091B-C ETL Verified Category 6A U/UTP Cable, blue jacket, 4 pair count, 1000 ft (305 m) length, WE TOTE® box	U/UTP	LSZH/Cca	3091B-C BL 4/23 W1000	760240841
	GigaSPEED X10D 3291B Category 6A F/UTP Cable, low smoke zero halogen, white jacket, 4 pair count, 1000 ft (305 m) length, reel	F/UTP	LSZH/Dca	3291B WHT C6A 4/23 F/UTP R1000	760081323
Field Installable Category 6A Information Outlets		Cu Tech	Jacket Material	Description Code	Part Number
	GigaSPEED X10D MGS600 Series Information Outlet, black	UTP	N/A	MGS600-003	760092361
	GigaSPEED X10D HGS620 Shielded High Density Information Outlet	STP	N/A	HGS620	760152801
Copper Patch Cords		Copper Tech	Jacket Material	Description Code	Part Number
	MiNo6A Series Category 6A U/UTP Reduced Diameter LS-CM Dual Rated Cord	UTP	LSZH/Riser	G10SP-L-WH	C0199K2-08
	GigaSPEED X10D G10SP on S/FTP Low Smoke Zero Halogen Cordage, S/FTP Modular Patch Cord, White Jacket	S/FTP	LSZH/Riser	G10SP-L-WH	CA111K2-08



Direct System Selection Index

BUDI	FACT ODF	UMSC	Flex Frame ODF, 19-in. Propel	FOSC 600	19-in. Splice	Rollable Ribbon Fiber	Other Products	Pre-term 19-in. Fiber	Pre-term FACT ODF Fiber	FiberGuide	Cable Mgmt Wire Baskets	Category 6A	Powered Fiber	DIN Rail	Fiber Wall Boxes	2 Post Equipment	imVision
------	----------	------	-------------------------------	----------	---------------	-----------------------	----------------	-----------------------	-------------------------	------------	-------------------------	-------------	---------------	----------	------------------	------------------	----------

Architecture System Selection Index

Colocation Campus and Building Infrastructure

Fiber Entrance, Meet-Me Room	High Fiber Count DC Interconnect	Campus Cabling	Building Cabling	IDF to Customer Cage (FACT ODF)	IDF to Customer Cage (19-in. Cabinet)	Campus Cabling for Wi-Fi and Security	MDA Fiber	EDA Fiber	EDA Copper	FiberGuide	MDA Cabinet	MDA Cross-connect 19-in.	MDA Cross-connect FACT ODF	IDF FACT	IDF 19-in.
------------------------------	----------------------------------	----------------	------------------	---------------------------------	---------------------------------------	---------------------------------------	-----------	-----------	------------	------------	-------------	--------------------------	----------------------------	----------	------------

Customer Space Cabling Infrastructure

Reference Designs and Technical Information



Powered Fiber Systems



Application

Deployment of HD cameras, Wi-Fi access points, optical network terminals, small cells (picocells, femtocells, metrocells, etc.) and other network access devices can be difficult, especially in outdoor environments. Many of these devices accept a power over Ethernet (PoE) input for power and communications. However, the PoE distance limitation of 100 meters can cause difficulties with network planning.

Also, power is not always readily available in the precise locations where device placement is needed to improve 4G LTE and/or 802.11 Wi-Fi coverage for wireless networks, such as on the sides of buildings, lamp posts, etc. In these situations, it is typically necessary to run power to the desired location prior to installing the devices. Also, any concern about who pays for that power and how it is monitored requires wireless network operators to negotiate with local utility companies and building owners. All of this adds time and money to the installation of network access devices.

CommScope has developed a solution that combines power and optical fiber communications into one system, eliminating the hassles and extra expense associated with powering typical low-power network devices.

Features

- Hybrid optical fiber and copper cabling with outdoor and indoor/outdoor versions
- Incorporates dc/dc conversion technology to simplify dc line powering calculations
- Primary, secondary, and tertiary electrical protection
- Media converter for delivering PoE and PoE+ capability
- SELV and NEC Class 2 compliant

Applications

- Security cameras
- Wi-Fi access points
- Wireless network small cells
- Optical network terminals

- Digital signage
- Emergency phones
- Additional devices needing PoE signal

[Learn more about powered fiber here.](#)

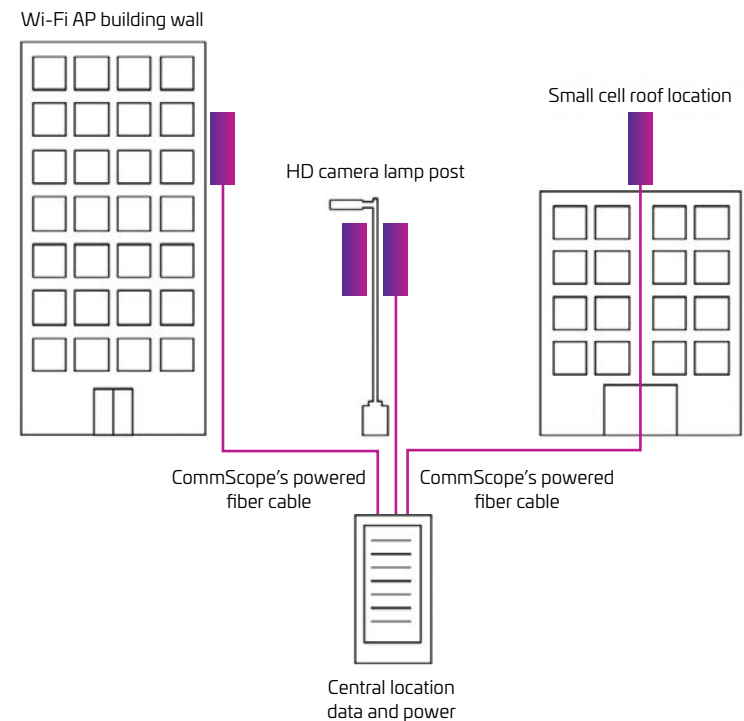

Direct System Selection Index

BUDI	FACT ODF	UMSC	Flex Frame ODF, 19-in. Propel	FOSC 600	19-in. Splice	Rollable Ribbon Fiber	Other Products	Pre-term 19-in. Fiber	Pre-term FACT ODF Fiber	FiberGuide	Cable Mgmt Wire Baskets	Category 6A	Powered Fiber	DIN Rail	Fiber Wall Boxes	2 Post Equipment	imVision
------	----------	------	-------------------------------	----------	---------------	-----------------------	----------------	-----------------------	-------------------------	------------	-------------------------	-------------	---------------	----------	------------------	------------------	----------

Architecture System Selection Index

Colocation Campus and Building Infrastructure

Fiber Entrance, Meet-Me Room	High Fiber Count DC Interconnect	Campus Cabling	Building Cabling	IDF to Customer Cage (FACT ODF)	IDF to Customer Cage (19-in. Cabinet)	Campus Cabling for Wi-Fi and Security	MDA Fiber	EDA Fiber	EDA Copper	FiberGuide	MDA Cabinet	MDA Cross-connect 19-in.	MDA Cross-connect FACT ODF	IDF FACT	IDF 19-in.
------------------------------	----------------------------------	----------------	------------------	---------------------------------	---------------------------------------	---------------------------------------	-----------	-----------	------------	------------	-------------	--------------------------	----------------------------	----------	------------

Customer Space Cabling Infrastructure

MDA Fiber	EDA Fiber	EDA Copper	FiberGuide
-----------	-----------	------------	------------

Reference Designs and Technical Information

MDA Cabinet	MDA Cross-connect 19-in.	MDA Cross-connect FACT ODF	IDF FACT	IDF 19-in.
-------------	--------------------------	----------------------------	----------	------------



1- and 2-Port PoE Extenders

- IP68 sealing—Enclosures are designed for outdoor installations with protection from moisture and the environment.
- Automatically corrects for distance voltage drop in the hybrid cable.
- Integrated Electrical Protection
- 60W 2-port variant enables 2 PoE or PoE+ devices to be connected via one hybrid cable.
- 60W single port variation supports 802.3bt, Class 6 power levels. It can be equipped with SPF+ transceivers, and deliver 5 Gbps Ethernet over the copper port.

Power Supplies

- 57VDC Power Supply for use with Powered Fiber Cable System

Support Materials

- [Find calculators and component details here.](#)
- [Find installation tips for the power supply at the central location here.](#)

Powered Fiber Cables	Part Number/MID
Powered Fiber Cable, Indoor/Outdoor, OS2, 2 Fibers, 2 x 12 AWG Conductors	PFC-S02L12
Powered Fiber Cable, Indoor/Outdoor, OS2, 2 Fibers, 2 x 16 AWG Conductors	PFC-S02L16
Powered Fiber Cable, Outdoor, OS2, 2 Fibers, 2 x 12 AWG Conductors	PFC-S02O12
Powered Fiber Cable, Outdoor, OS2, 2 Fibers, 2 x 16 AWG Conductors	PFC-S02O16
Powered Fiber Cable, Indoor/Outdoor, OS2, 4 Fibers, 2 x 12 AWG Conductors	PFC-S04L12
Powered Fiber Cable, Indoor/Outdoor, OS2, 4 Fibers, 2 x 16 AWG Conductors	PFC-S04L16
Powered Fiber Cable, Outdoor, OS2, 4 Fibers, 2 x 12 AWG Conductors	PFC-S04O12
Powered Fiber Cable, Outdoor, OS2, 4 Fibers, 2 x 16 AWG Conductors	PFC-S04O16
Powered Fiber Cable, Indoor/Outdoor, OS2, 12 Fibers, 2 x 12 AWG Conductors	PFC-S12L12
Powered Fiber Cable, Indoor/Outdoor, OS2, 2 Fibers, 12 x 16 AWG Conductors	PFC-S12L16
Powered Fiber Cable, Outdoor, OS2, 12 Fibers, 2 x 12 AWG Conductors	PFC-S12O12
Powered Fiber Cable, Outdoor, OS2, 12 Fibers, 2 x 16 AWG Conductors	PFC-S12O16
Powered Fiber Cable, Indoor/Outdoor, OM3, 2 Fibers, 2 x 12 AWG Conductors	PFC-302L12
Powered Fiber Cable, Indoor/Outdoor, OM3, 2 Fibers, 2 x 16 AWG Conductors	PFC-302L16
Powered Fiber Cable, Outdoor, OM3, 2 Fibers, 2 x 12 AWG Conductors	PFC-302O12
Powered Fiber Cable, Outdoor, OM3, 2 Fibers, 2 x 16 AWG Conductors	PFC-302O16
Powered Fiber Cable, Indoor/Outdoor, OM3, 4 Fibers, 2 x 12 AWG Conductors	PFC-304L12
Powered Fiber Cable, Indoor/Outdoor, OM3, 4 Fibers, 2 x 16 AWG Conductors	PFC-304L16
Powered Fiber Cable, Outdoor, OM3, 4 Fibers, 2 x 12 AWG Conductors	PFC-304O12
Powered Fiber Cable, Outdoor, OM3, 4 Fibers, 2 x 16 AWG Conductors	PFC-304O16

1- and 2-Port PoE Extenders	Part Number/MID
60W, 2 Port PoE Extender (provides a maximum of 30W on each port)	PFU-P-C-O-060-02
60W, 1 Port 5 Gbps PoE Extender	PFU-P-E-O-060-01
Power Supplies	Part Number/MID
Power Express Distribution shelf with alarm module	PFP-PX-S1
Power Express Distribution module supports max. 8 Devices	PFP-PX-8M
Power Express Blank Slot Panel	PFP-PX-SF
SPS Rectifier Power Distribution Shelf	PFP-SPS-S1
1600W SPS Power Rectifier module	PFP-SPS-1600M
SPS Rectifier Controller Display	PFP-SPS-C1
SPS Rectifier Blank Slot Panel	PFP-SPS-SF



Direct System Selection Index

BUDI	FACT ODF	UMSC	Flex Frame ODF, 19-in. Propel	FOSC 600	19-in. Splice	Rollable Ribbon Fiber	Other Products	Pre-term 19-in. Fiber	Pre-term FACT ODF Fiber	FiberGuide	Cable Mgmt Wire Baskets	Category 6A	Powered Fiber	DIN Rail	Fiber Wall Boxes	2 Post Equipment	imVision
------	----------	------	-------------------------------	----------	---------------	-----------------------	----------------	-----------------------	-------------------------	------------	-------------------------	-------------	---------------	----------	------------------	------------------	----------

Architecture System Selection Index

Colocation Campus and Building Infrastructure

Fiber Entrance, Meet-Me Room	High Fiber Count DC Interconnect	Campus Cabling	Building Cabling	IDF to Customer Cage (FACT ODF)	IDF to Customer Cage (19-in. Cabinet)	Campus Cabling for Wi-Fi and Security	MDA Fiber	EDA Fiber	EDA Copper	FiberGuide	MDA Cabinet	MDA Cross-connect 19-in.	MDA Cross-connect FACT ODF	IDF FACT	IDF 19-in.
------------------------------	----------------------------------	----------------	------------------	---------------------------------	---------------------------------------	---------------------------------------	-----------	-----------	------------	------------	-------------	--------------------------	----------------------------	----------	------------

Customer Space Cabling Infrastructure

Reference Designs and Technical Information



DIN Rail Solutions for BMS Networks



A Building Management System (BMS), or Building Energy Management System (BEMS), supports the automatic centralized control of a building's HVAC (heating, ventilation and air conditioning), electrical, lighting, shading, access control, security systems, and other interrelated systems.

In addition to controlling the building's internal environment, BMS systems are sometimes linked to access control or other security systems such as closed-circuit television (CCTV), motion detectors, fire alarm systems, and elevators for monitoring.

Many of the devices used to enable the applications mentioned in the previous paragraph have a non-standard foot print, or are located in places where a traditional 19-in rack or cabinet cannot be placed. In this instance, DIN (Deutsche Instiut fur Normung), a rail-mounted metal strip system, is deployed to securely attach those electrical and industrial control products and sensors.



Direct System Selection Index

BUDI	FACT ODF	UMSC	Flex Frame ODF, 19-in. Propel	FOSC 600	19-in. Splice	Rollable Ribbon Fiber	Other Products	Pre-term 19-in. Fiber	Pre-term FACT ODF Fiber	FiberGuide	Cable Mgmt Wire Baskets	Category 6A	Powered Fiber	DIN Rail	Fiber Wall Boxes	2 Post Equipment	imVision
------	----------	------	-------------------------------	----------	---------------	-----------------------	----------------	-----------------------	-------------------------	------------	-------------------------	-------------	---------------	----------	------------------	------------------	----------

Architecture System Selection Index

Colocation Campus and Building Infrastructure

Fiber Entrance, Meet-Me Room	High Fiber Count DC Interconnect	Campus Cabling	Building Cabling	IDF to Customer Cage (FACT ODF)	IDF to Customer Cage (19-in. Cabinet)	Campus Cabling for Wi-Fi and Security
------------------------------	----------------------------------	----------------	------------------	---------------------------------	---------------------------------------	---------------------------------------

Customer Space Cabling Infrastructure

MDA Fiber	EDA Fiber	EDA Copper	FiberGuide
-----------	-----------	------------	------------

Reference Designs and Technical Information

MDA Cabinet	MDA Cross-connect 19-in.	MDA Cross-connect FACT ODF	IDF FACT	IDF 19-in.
-------------	--------------------------	----------------------------	----------	------------



Review DIN Rail System Selection [here](#).

DIN Rail Mounting Bracket and Enclosure	Description Code	Part Number
DIN rail mounting bracket for WBE-EMT-BK-1P-PNL	WBE-1P-DIN-KIT	760239822
Ready Wall Mount Building Enclosure, 1P, black, cable gland not included	WBE-EMT-BK-1P-PNL	760172288
1000 Style to 360 Adapter Pack Bracket Kit (Kit of 3)	1000-360-ADPT-BRKT-KIT	760198325
Fiber Pigtails and Accessories	Description Code	Part Number
TeraSPEED LC/UPC to Unconnectorized, Fiber Pigtail, 0.9 mm Tight Buffer		FAWLCUC01
OM4 LC/UPC to Unconnectorized, 0.9 mm Tight Buffer Simplex Fiber Pigtail		FAXLCUC01
SYSTIMAX 360 Fusion Splice Holder Kit, stackable	360-SPLICE-24-FUS	760148536
Fiber Optic Single Fusion Splice Sleeve, 50 Pack	SFS-SLEEVE-60MM-50 PACK	9701008/00
Fiber Adapter Packs	Description Code	Part Number
360 Distribution Adapter Pack, Singlemode, 24 LC/UPC with internal shutters	360DPis-24LC-SM	760216762
360 Distribution Adapter Pack, Singlemode, 12 LC/UPC with internal shutters	360DPis-12LC-SM	760230946
360 Distribution Adapter Pack, Multimode OM4, 24 LC/UPC with internal shutters	360DPis-24LC-LS	760216754
360 Distribution Adapter Pack, Multimode OM4, 12 LC/UPC with internal shutters	360DPis-12LC-LS	760230938
Copper Faceplate and Jacks	Description Code	Part Number
G2 Multimedia Outlet Bezel for G2 Modular Shelf, Accepts 4 MGS Jacks	MODG2-MGS	760032110
C6A UTP GigaSPEED X10D MGS600 Series Information Outlet, black, quantity 1	MGS600-003	760092361
GigaSPEED XL MGS400 Series Category 6 U/UTP Information Outlet, black, quantity 1	MGS400-003	700206667

Direct System Selection Index

BUDI	FACT ODF	UMSC	Flex Frame ODF, 19-in. Propel	FOSC 600	19-in. Splice	Rollable Ribbon Fiber	Other Products	Pre-term 19-in. Fiber	Pre-term FACT ODF Fiber	FiberGuide	Cable Mgmt Wire Baskets	Category 6A	Powered Fiber	DIN Rail	Fiber Wall Boxes	2 Post Equipment	imVision
----------------------	--------------------------	----------------------	---	--------------------------	-------------------------------	---------------------------------------	--------------------------------	---------------------------------------	---	----------------------------	---	-----------------------------	-------------------------------	--------------------------	----------------------------------	----------------------------------	--------------------------

Architecture System Selection Index

Colocation Campus and Building Infrastructure

Fiber Entrance, Meet-Me Room	High Fiber Count DC Interconnect	Campus Cabling	Building Cabling	IDF to Customer Cage (FACT ODF)	IDF to Customer Cage (19-in. Cabinet)
--	--	--------------------------------	----------------------------------	---	---

Customer Space Cabling Infrastructure

Campus Cabling for Wi-Fi and Security	MDA Fiber	EDA Fiber	EDA Copper	FiberGuide
---	---------------------------	---------------------------	----------------------------	----------------------------

Reference Designs and Technical Information

MDA Cabinet	MDA Cross-connect 19-in.	MDA Cross-connect FACT ODF	IDF FACT	IDF 19-in.
-----------------------------	--	--	--------------------------	----------------------------



Fiber Wall Boxes for Fiber Entrance Applications



Fiber Wall Boxes	Dimensions	Description Code	Part Number
Wall Mount Building Enclosure configured for one G2 Style module, splice cassette or adapter pack, cable gland not included	139.7 mm x 262.64 mm x 35.81 mm	WB2-EMT-BK-1P-MOD	760248900
Wall Mount Building Enclosure configured for two G2 Style modules, splice cassettes or adapter packs, cable gland not included	284.99 mm x 367.28 mm x 52.83 mm	WB2-EMT-BK-2P-MOD	760248901
Wall Mount Building Enclosure configured for four G2 style modules, splice cassettes or adapter packs, cable gland not included	284.99 mm x 367.28 mm x 98.55 mm	WB2-EMT-BK-4P-MOD	760248902
Wall Mount Building Enclosure configured for eight G2 Style modules, splice cassettes or adapter packs, cable gland not included	284.99 mm x 367.28 mm x 158.75 mm	WB2-EMT-BK-8P-MOD	760248903



Direct System Selection Index

BUDI	FACT ODF	UMSC	Flex Frame ODF, 19-in. Propel	FOSC 600	19-in. Splice	Rollable Ribbon Fiber	Other Products	Pre-term 19-in. Fiber	Pre-term FACT ODF Fiber	FiberGuide	Cable Mgmt Wire Baskets	Category 6A	Powered Fiber	DIN Rail	Fiber Wall Boxes	2 Post Equipment	imVision
------	----------	------	-------------------------------	----------	---------------	-----------------------	----------------	-----------------------	-------------------------	------------	-------------------------	-------------	---------------	----------	------------------	------------------	----------

Architecture System Selection Index

Colocation Campus and Building Infrastructure

Fiber Entrance, Meet-Me Room	High Fiber Count DC Interconnect	Campus Cabling	Building Cabling	IDF to Customer Cage (FACT ODF)	IDF to Customer Cage (19-in. Cabinet)	Campus Cabling for Wi-Fi and Security	MDA Fiber	EDA Fiber	EDA Copper	FiberGuide	MDA Cabinet	MDA Cross-connect 19-in.	MDA Cross-connect FACT ODF	IDF FACT	IDF 19-in.
------------------------------	----------------------------------	----------------	------------------	---------------------------------	---------------------------------------	---------------------------------------	-----------	-----------	------------	------------	-------------	--------------------------	----------------------------	----------	------------

Customer Space Cabling Infrastructure

Reference Designs and Technical Information



2 Post Equipment Racks and Accessories



Equipment Racks	Material	Static Load Rating	Packaging Type and Weight (net)	Description Code	Part Number
Equipment Rack, 2-Post, 3 in (76 mm) Channel x 7ft (2134 mm) H - 19 in (482.6 mm) Alu (45U) 12-24 Tapped Rails, Black	Aluminium	453.6 kg	Flat Packed 12.7 kg	RK3-45A	760082479
Horizontal Cable Managers	Material	Color	Packaging Type and Weight (net)	Description Code	Part Number
Horizontal Trough Kit, 1 RU, 19 in, single sided	Aluminium, Steel	Black	Assembled 1.52 kg	HTK-19-SS-1U	760072942
Horizontal Trough Kit, 2 RU, 19 in, single sided	Aluminium, Steel	Black	Assembled 2.05 kg	HTK-19-SS-2U	760072959
Horizontal Trough Kit, 19 in rack mountable, double sided, 1 RU	Aluminium, Plastic, Steel	Black	Assembled	HTK-19-DS-1U	760128843
Horizontal Trough Kit, 19 in rack mountable, double sided, 2 RU	Aluminium, Plastic, Steel	Black	Assembled	HTK-19-DS-2U	760128850
Vertical Cable Managers, Silver	Material	Color	Packaging Type and Weight (net)	Description Code	Part Number
Vertical Cable Management Kit, 6 in x 84 in (152 mm x 2134 mm) Double Sided, With Doors	Metal	Silver	Assembled	VCM-DS-84-6	760244775
Vertical Cable Management Kit, 8 in x 84 in (203 mm x 2134 mm) Double Sided, With Doors	Metal	Silver	Assembled	VCM-DS-84-8	760244776
Vertical Cable Management Kit, 10 in x 84 in (254 mm x 2134 mm) Double Sided, With Doors	Metal	Silver	Assembled	VCM-DS-84-10	760244777
Vertical Cable Management Kit, 12 in x 84 in (305 mm x 2134 mm) Double Sided, With Doors	Metal	Silver	Assembled	VCM-DS-84-12	760244778
Vertical Cable Managers, Black	Material	Color	Packaging Type and Weight (net)	Description Code	Part Number
Vertical Cable Management Kit, 6 in x 84 in (152 mm x 2134 mm) Double Sided, With Doors	Metal	Black	Assembled	VCM-DS-84-6B	760244779
Vertical Cable Management Kit, 8 in x 84 in (203 mm x 2134 mm) Double Sided, With Doors	Metal	Black	Assembled 30.391 kg	VCM-DS-84-8B	760244780
Vertical Cable Management Kit, 10 in x 84 in (254 mm x 2134 mm) Double Sided, With Doors	Metal	Black	Assembled	VCM-DS-84-10B	760244781
Vertical Cable Management Kit, 12 in x 84 in (305 mm x 2134 mm) Double Sided, With Doors	Metal	Black	Assembled	VCM-DS-84-12B	760244782



Contact your local CommScope FAE for more details.

Direct System Selection Index

BUDI	FACT ODF	UMSC	Flex Frame ODF, 19-in. Propel	FOSC 600	19-in. Splice	Rollable Ribbon Fiber	Other Products	Pre-term 19-in. Fiber	Pre-term FACT ODF Fiber	FiberGuide	Cable Mgmt Wire Baskets	Category 6A	Powered Fiber	DIN Rail	Fiber Wall Boxes	2 Post Equipment	imVision
------	----------	------	-------------------------------	----------	---------------	-----------------------	----------------	-----------------------	-------------------------	------------	-------------------------	-------------	---------------	----------	------------------	------------------	----------

Architecture System Selection Index

Colocation Campus and Building Infrastructure

Fiber Entrance, Meet-Me Room	High Fiber Count DC Interconnect	Campus Cabling	Building Cabling	IDF to Customer Cage (FACT ODF)	IDF to Customer Cage (19-in. Cabinet)	Campus Cabling for Wi-Fi and Security	MDA Fiber	EDA Fiber	EDA Copper	FiberGuide	MDA Cabinet	MDA Cross-connect 19-in.	MDA Cross-connect FACT ODF	IDF FACT	IDF 19-in.
------------------------------	----------------------------------	----------------	------------------	---------------------------------	---------------------------------------	---------------------------------------	-----------	-----------	------------	------------	-------------	--------------------------	----------------------------	----------	------------

Customer Space Cabling Infrastructure

Reference Designs and Technical Information



CommScope's imVision[®] Platform



Data drives your network. To keep it flowing efficiently and freely, your physical layer infrastructure must be managed in real-time, using authoritative information—not assumptions. Gaining the visibility and insights needed to make the right decisions gets tougher as networks converge and grow more complex. That's why CommScope created imVision, the industry's leading automated infrastructure management (AIM) platform.

With an intuitive, web-based architecture, imVision delivers real-time intelligence and device discovery that allow you to monitor and document your cabling infrastructure while tracking the location of all connected network devices. It delivers actionable, real-time data and performance insights that enable you to optimize capacity, availability and efficiency. The critical information you need from the technology partner you trust.

Optimize capacity

Today's networks are capacity-strained but often have resources that are not being utilized efficiently. A capacity upgrade is involved and costly and may even be unnecessary. How can you be sure?

Optimize availability

Nobody can afford a service disruption. Worse yet, is the cost to resolve unplanned downtime. The best way to lower the cost is to prevent service issues from ever happening.

Optimize efficiency

Nothing degrades network efficiency like stranded switch ports. Left unidentified, they continue to consume power and valuable white space. The cost and time needed to deploy and commission new servers is another efficiency-killer.

[Learn more about automated infrastructure management here.](#)

[Explore imVision case studies at commscope.com](#)

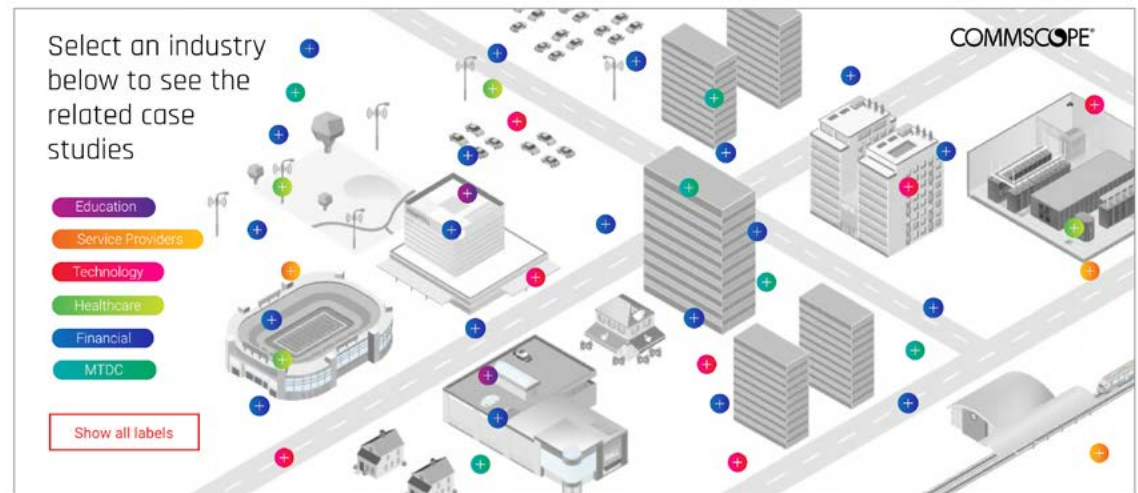

Direct System Selection Index

BUDI	FACT ODF	UMSC	Flex Frame ODF, 19-in. Propel	FOSC 600	19-in. Splice	Rollable Ribbon Fiber	Other Products	Pre-term 19-in. Fiber	Pre-term FACT ODF Fiber	FiberGuide	Cable Mgmt Wire Baskets	Category 6A	Powered Fiber	DIN Rail	Fiber Wall Boxes	2 Post Equipment	imVision
------	----------	------	-------------------------------	----------	---------------	-----------------------	----------------	-----------------------	-------------------------	------------	-------------------------	-------------	---------------	----------	------------------	------------------	----------

Architecture System Selection Index

Colocation Campus and Building Infrastructure

Fiber Entrance, Meet-Me Room	High Fiber Count DC Interconnect	Campus Cabling	Building Cabling	IDF to Customer Cage (FACT ODF)	IDF to Customer Cage (19-in. Cabinet)	Campus Cabling for Wi-Fi and Security	MDA Fiber	EDA Fiber	EDA Copper	FiberGuide	MDA Cabinet	MDA Cross-connect 19-in.	MDA Cross-connect FACT ODF	IDF FACT	IDF 19-in.
------------------------------	----------------------------------	----------------	------------------	---------------------------------	---------------------------------------	---------------------------------------	-----------	-----------	------------	------------	-------------	--------------------------	----------------------------	----------	------------

Customer Space Cabling Infrastructure

Reference Designs and Technical Information



Colocation Campus and Building Infrastructure

Overview

Fiber Entrance and Meet-Me Room

High Fiber Count DC Interconnect

Campus Cabling

Building Cabling

IDF to Customer Cage (FACT ODF)

IDF to Customer Cage (19-in. Cabinet)

Campus Cabling for Wi-Fi and Security



Select a cabling section for more information.

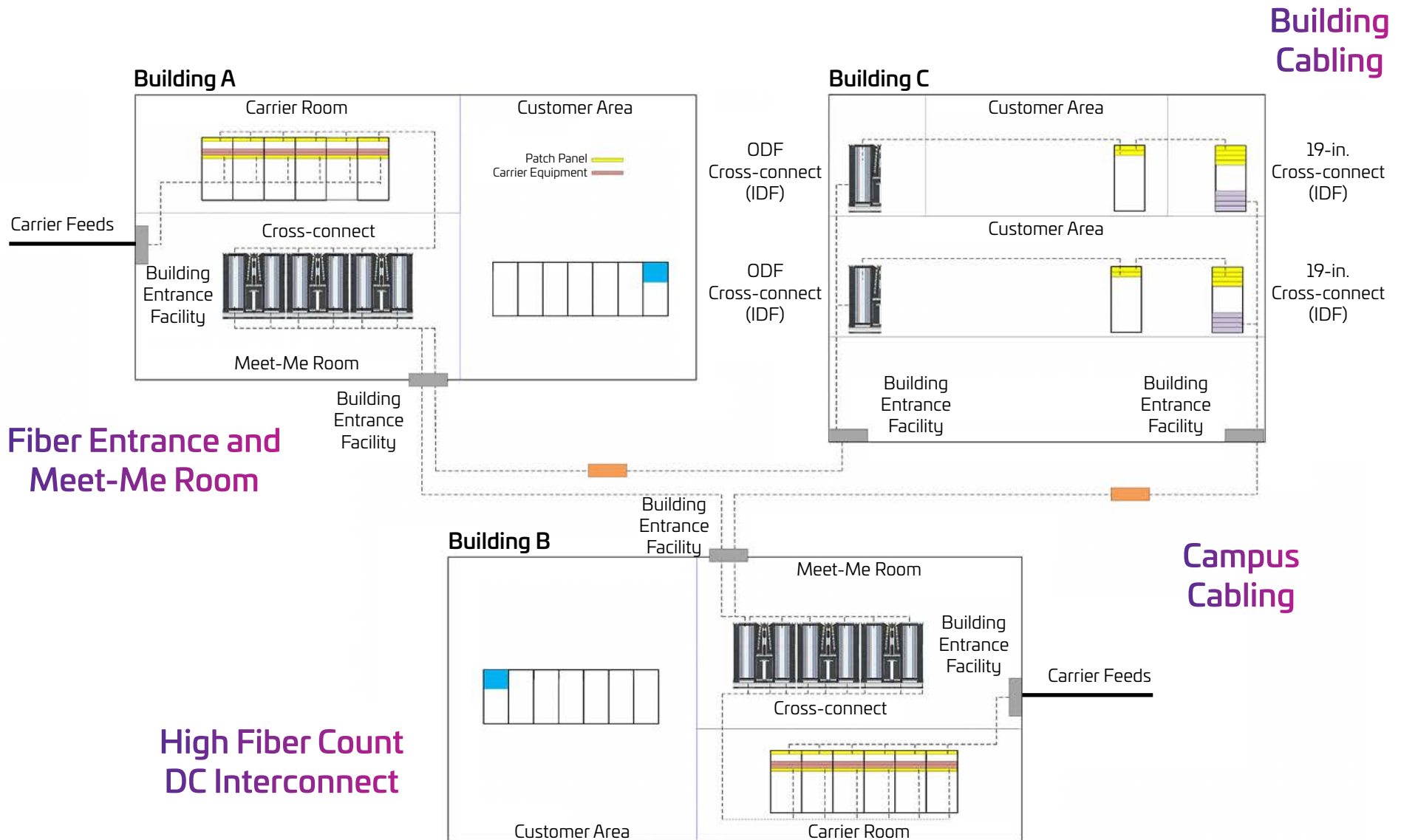

Direct System Selection Index

BUDI	FACT ODF	UMSC	Flex Frame ODF, 19-in. Propel	FOSC 600	19-in. Splice	Rollable Ribbon Fiber	Other Products	Pre-term 19-in. Fiber	Pre-term FACT ODF Fiber	FiberGuide	Cable Mgmt Wire Baskets	Category 6A	Powered Fiber	DIN Rail	Fiber Wall Boxes	2 Post Equipment	imVision
------	----------	------	-------------------------------	----------	---------------	-----------------------	----------------	-----------------------	-------------------------	------------	-------------------------	-------------	---------------	----------	------------------	------------------	----------

Architecture System Selection Index

Colocation Campus and Building Infrastructure

Fiber Entrance, Meet-Me Room	High Fiber Count DC Interconnect	Campus Cabling	Building Cabling	IDF to Customer Cage (FACT ODF)	IDF to Customer Cage (19-in. Cabinet)	Campus Cabling for Wi-Fi and Security	MDA Fiber	EDA Fiber	EDA Copper	FiberGuide	MDA Cabinet	MDA Cross-connect 19-in.	MDA Cross-connect FACT ODF	IDF FACT	IDF 19-in.
------------------------------	----------------------------------	----------------	------------------	---------------------------------	---------------------------------------	---------------------------------------	-----------	-----------	------------	------------	-------------	--------------------------	----------------------------	----------	------------

Customer Space Cabling Infrastructure

Reference Designs and Technical Information



Select a product for more information.

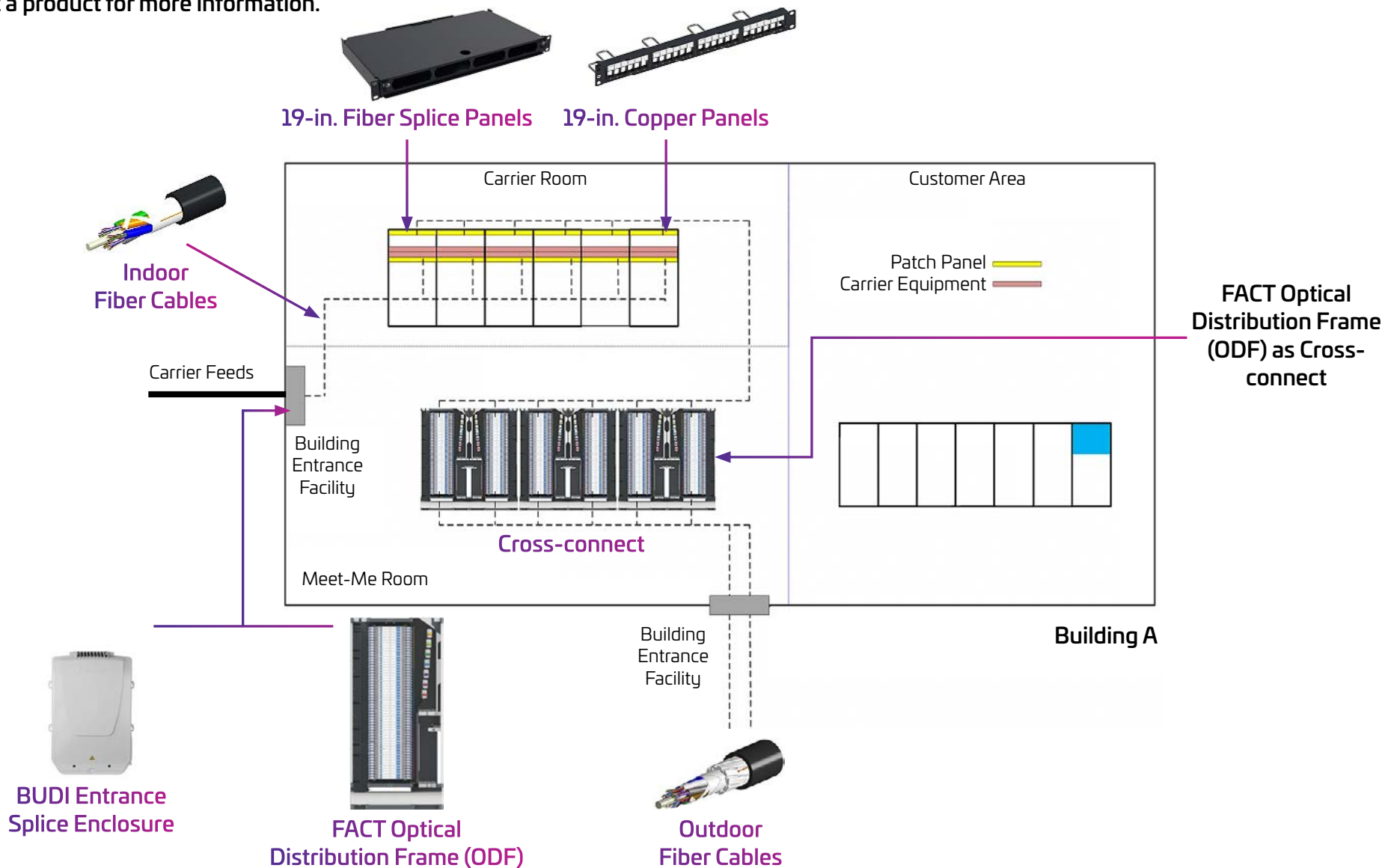

Direct System Selection Index

BUDI	FACT ODF	UMSC	Flex Frame ODF, 19-in. Propel	FOSC 600	19-in. Splice	Rollable Ribbon Fiber	Other Products	Pre-term 19-in. Fiber	Pre-term FACT ODF Fiber	FiberGuide	Cable Mgmt Wire Baskets	Category 6A	Powered Fiber	DIN Rail	Fiber Wall Boxes	2 Post Equipment	imVision
------	----------	------	-------------------------------	----------	---------------	-----------------------	----------------	-----------------------	-------------------------	------------	-------------------------	-------------	---------------	----------	------------------	------------------	----------

Architecture System Selection Index

Colocation Campus and Building Infrastructure

Fiber Entrance, Meet-Me Room	High Fiber Count DC Interconnect	Campus Cabling	Building Cabling	IDF to Customer Cage (FACT ODF)	IDF to Customer Cage (19-in. Cabinet)	Campus Cabling for Wi-Fi and Security	MDA Fiber	EDA Fiber	EDA Copper	FiberGuide	MDA Cabinet	MDA Cross-connect 19-in.	MDA Cross-connect FACT ODF	IDF FACT	IDF 19-in.
------------------------------	----------------------------------	----------------	------------------	---------------------------------	---------------------------------------	---------------------------------------	-----------	-----------	------------	------------	-------------	--------------------------	----------------------------	----------	------------

Customer Space Cabling Infrastructure

Reference Designs and Technical Information



Select a product for more information.

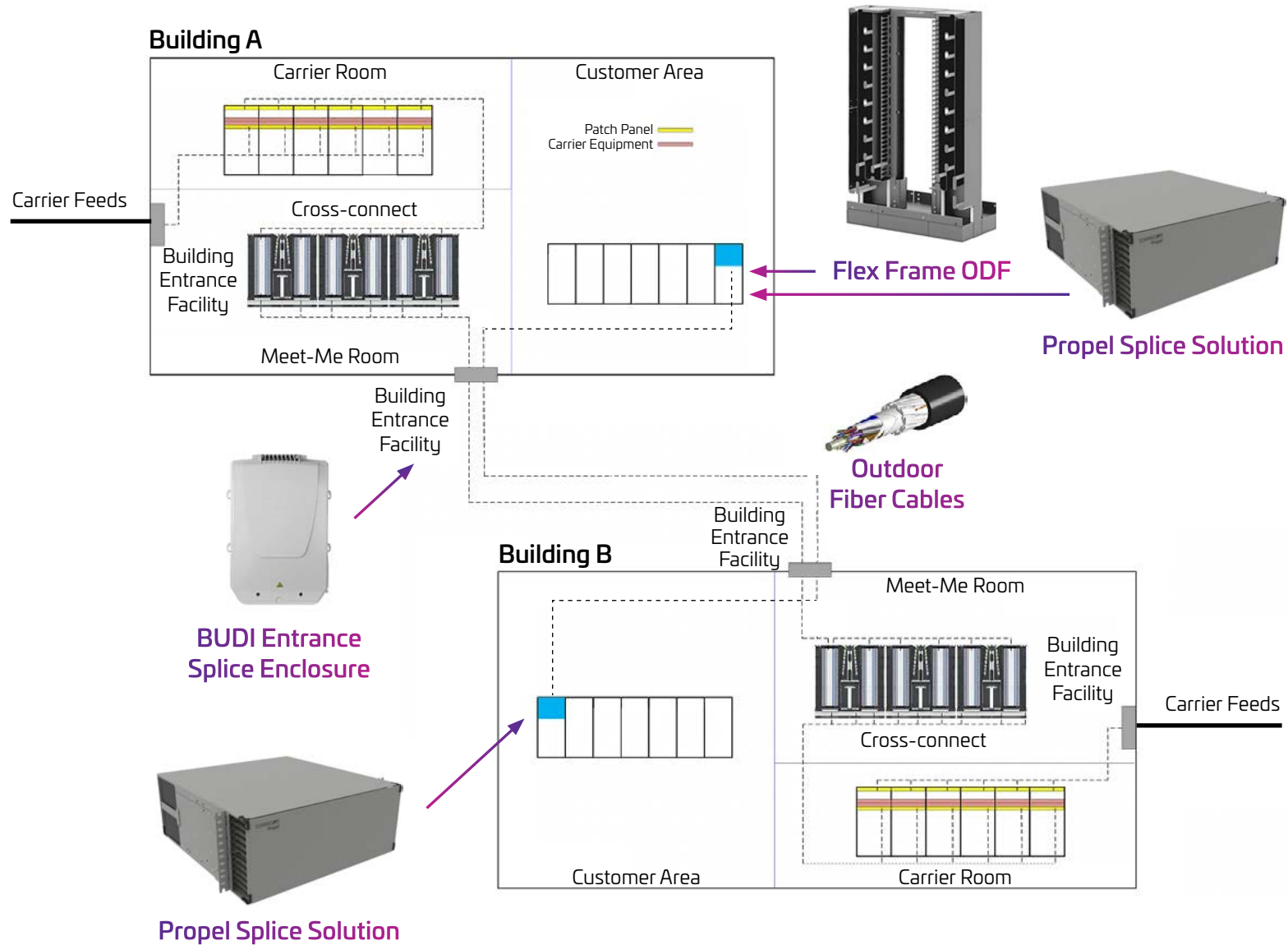

Direct System Selection Index

BUDI	FACT ODF	UMSC	Flex Frame ODF, 19-in. Propel	FOSC 600	19-in. Splice	Rollable Ribbon Fiber	Other Products	Pre-term 19-in. Fiber	Pre-term FACT ODF Fiber	FiberGuide	Cable Mgmt Wire Baskets	Category 6A	Powered Fiber	DIN Rail	Fiber Wall Boxes	2 Post Equipment	imVision
------	----------	------	-------------------------------	----------	---------------	-----------------------	----------------	-----------------------	-------------------------	------------	-------------------------	-------------	---------------	----------	------------------	------------------	----------

Architecture System Selection Index

Colocation Campus and Building Infrastructure

Fiber Entrance, Meet-Me Room	High Fiber Count DC Interconnect	Campus Cabling	Building Cabling	IDF to Customer Cage (FACT ODF)	IDF to Customer Cage (19-in. Cabinet)	Campus Cabling for Wi-Fi and Security	MDA Fiber	EDA Fiber	EDA Copper	FiberGuide	MDA Cabinet	MDA Cross-connect 19-in.	MDA Cross-connect FACT ODF	IDF FACT	IDF 19-in.
------------------------------	----------------------------------	----------------	------------------	---------------------------------	---------------------------------------	---------------------------------------	-----------	-----------	------------	------------	-------------	--------------------------	----------------------------	----------	------------

Customer Space Cabling Infrastructure

Reference Designs and Technical Information



Select a product for more information.

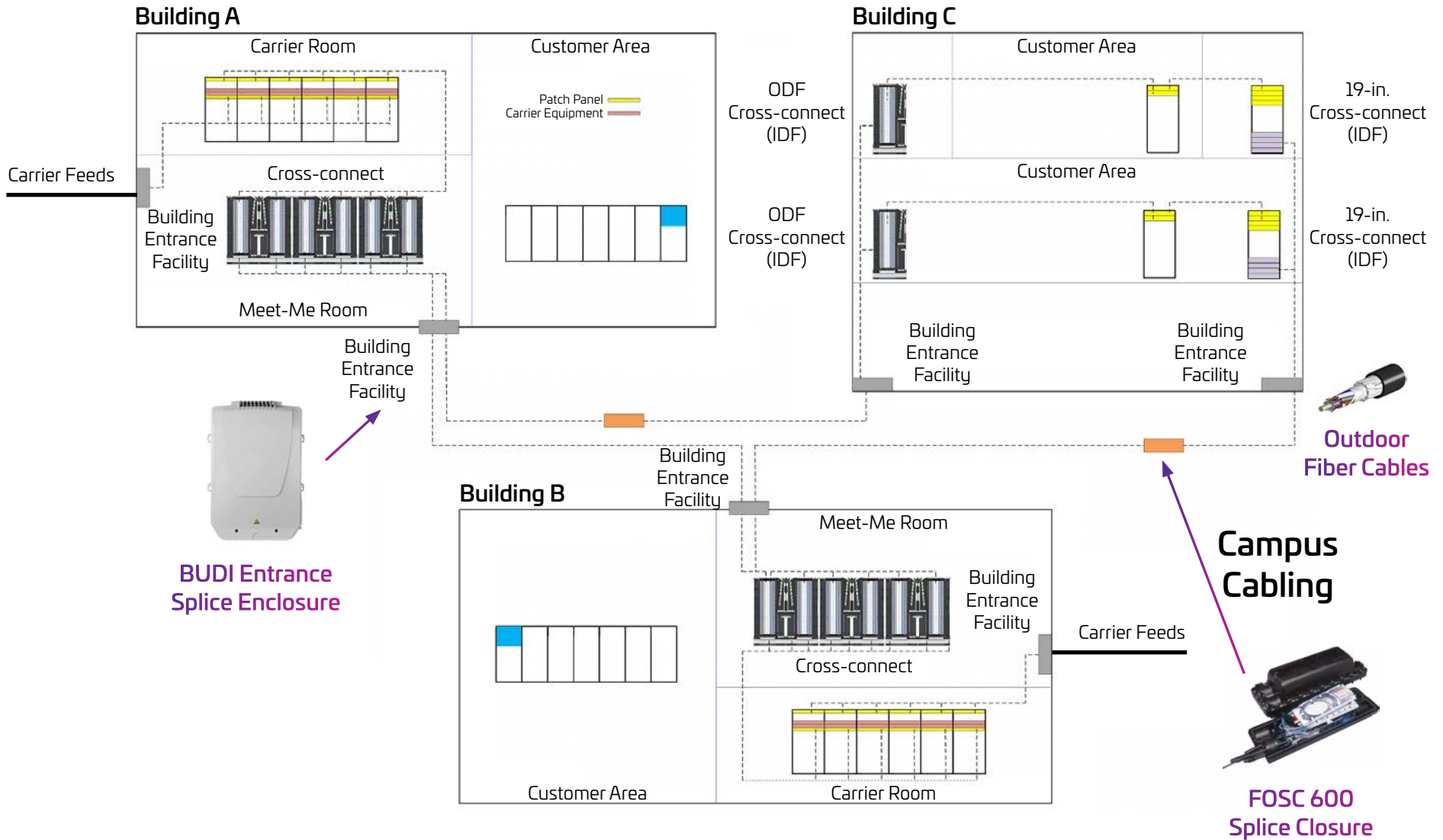

Direct System Selection Index

BUDI	FACT ODF	UMSC	Flex Frame ODF, 19-in. Propel	FOSC 600	19-in. Splice	Rollable Ribbon Fiber	Other Products	Pre-term 19-in. Fiber	Pre-term FACT ODF Fiber	FiberGuide	Cable Mgmt Wire Baskets	Category 6A	Powered Fiber	DIN Rail	Fiber Wall Boxes	2 Post Equipment	imVision
------	----------	------	-------------------------------	----------	---------------	-----------------------	----------------	-----------------------	-------------------------	------------	-------------------------	-------------	---------------	----------	------------------	------------------	----------

Architecture System Selection Index

Colocation Campus and Building Infrastructure

Fiber Entrance, Meet-Me Room	High Fiber Count DC Interconnect	Campus Cabling	Building Cabling	IDF to Customer Cage (FACT ODF)	IDF to Customer Cage (19-in. Cabinet)	Campus Cabling for Wi-Fi and Security	MDA Fiber	EDA Fiber	EDA Copper	FiberGuide	MDA Cabinet	MDA Cross-connect 19-in.	MDA Cross-connect FACT ODF	IDF FACT	IDF 19-in.
------------------------------	----------------------------------	----------------	------------------	---------------------------------	---------------------------------------	---------------------------------------	-----------	-----------	------------	------------	-------------	--------------------------	----------------------------	----------	------------

Customer Space Cabling Infrastructure

Reference Designs and Technical Information



Select a product for more information.

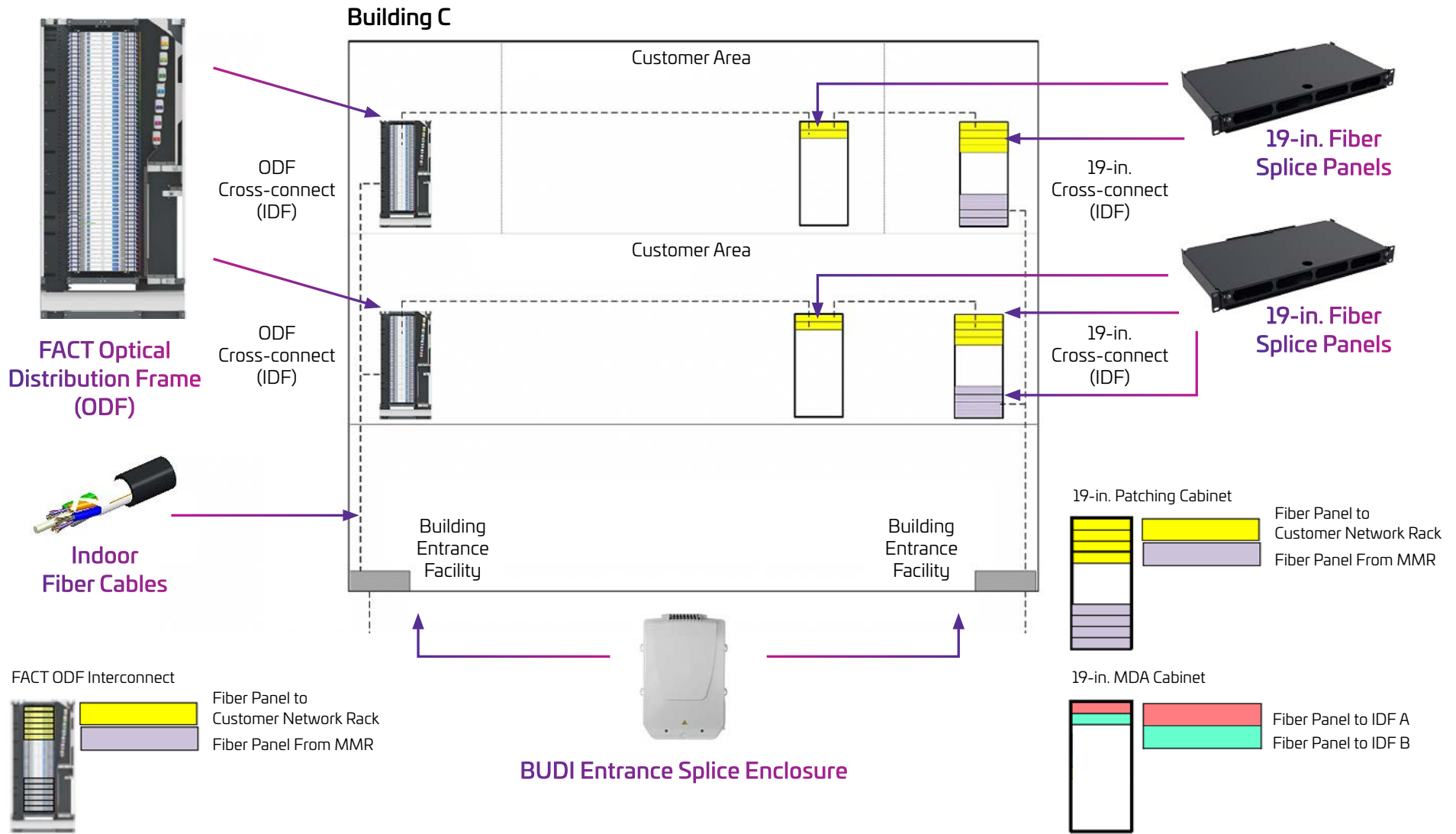

Direct System Selection Index

BUDI	FACT ODF	UMSC	Flex Frame ODF, 19-in. Propel	FOSC 600	19-in. Splice	Rollable Ribbon Fiber	Other Products	Pre-term 19-in. Fiber	Pre-term FACT ODF Fiber	FiberGuide	Cable Mgmt Wire Baskets	Category 6A	Powered Fiber	DIN Rail	Fiber Wall Boxes	2 Post Equipment	imVision
------	----------	------	-------------------------------	----------	---------------	-----------------------	----------------	-----------------------	-------------------------	------------	-------------------------	-------------	---------------	----------	------------------	------------------	----------

Architecture System Selection Index

Colocation Campus and Building Infrastructure

Fiber Entrance, Meet-Me Room	High Fiber Count DC Interconnect	Campus Cabling	Building Cabling	IDF to Customer Cage (FACT ODF)	IDF to Customer Cage (19-in. Cabinet)	Campus Cabling for Wi-Fi and Security	MDA Fiber	EDA Fiber	EDA Copper	FiberGuide	MDA Cabinet	MDA Cross-connect 19-in.	MDA Cross-connect FACT ODF	IDF FACT	IDF 19-in.
------------------------------	----------------------------------	----------------	------------------	---------------------------------	---------------------------------------	---------------------------------------	-----------	-----------	------------	------------	-------------	--------------------------	----------------------------	----------	------------

Customer Space Cabling Infrastructure

Reference Designs and Technical Information

Fiber Entrance, Meet-Me Room	High Fiber Count DC Interconnect	Campus Cabling	Building Cabling	IDF to Customer Cage (FACT ODF)	IDF to Customer Cage (19-in. Cabinet)	Campus Cabling for Wi-Fi and Security	MDA Fiber	EDA Fiber	EDA Copper	FiberGuide	MDA Cabinet	MDA Cross-connect 19-in.	MDA Cross-connect FACT ODF	IDF FACT	IDF 19-in.
------------------------------	----------------------------------	----------------	------------------	---------------------------------	---------------------------------------	---------------------------------------	-----------	-----------	------------	------------	-------------	--------------------------	----------------------------	----------	------------



Select a product for more information.

FACT IDF to Customer Cage: Splice Scenario

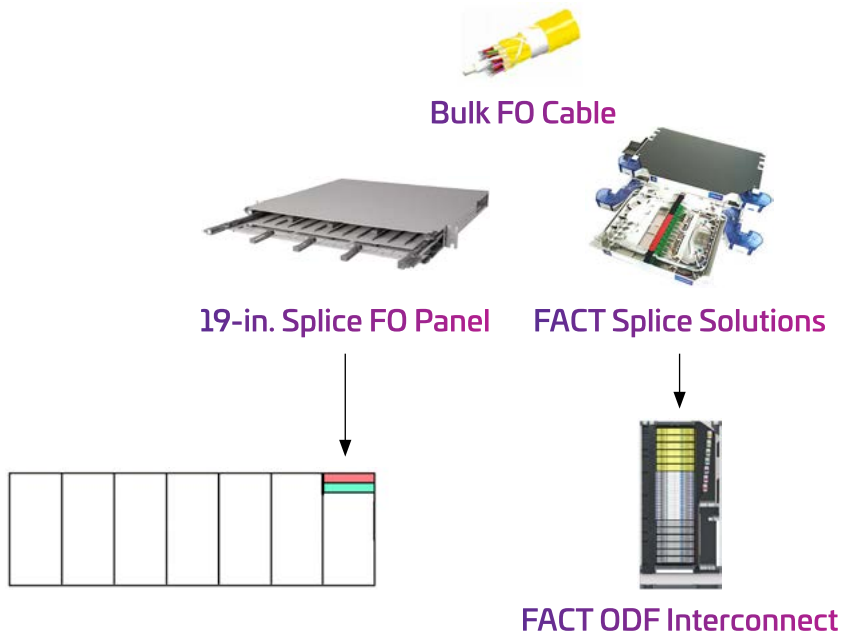

FACT IDF to Customer Cage: MPO Pre-terminated Scenario

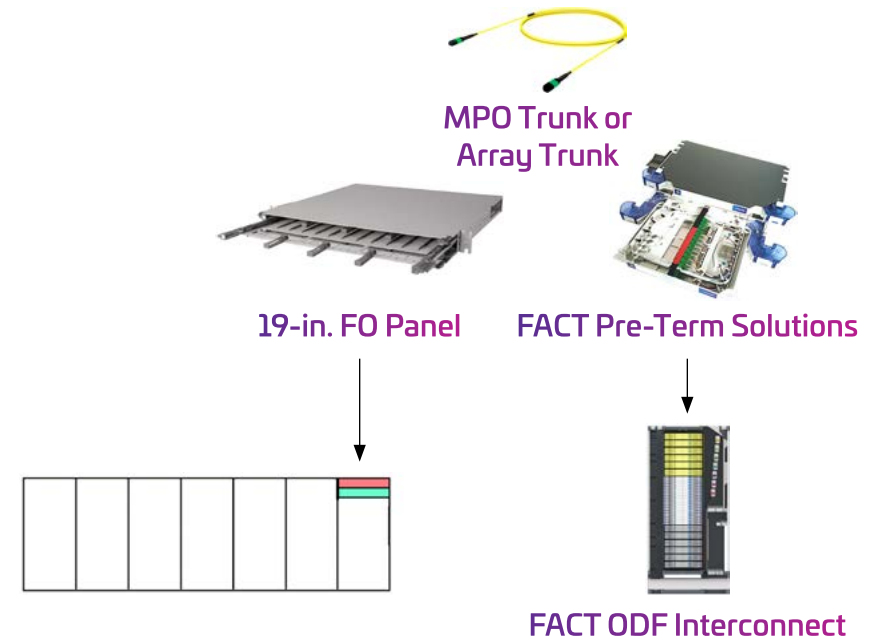

Direct System Selection Index

BUDI	FACT ODF	UMSC	Flex Frame ODF, 19-in. Propel	FOSC 600	19-in. Splice	Rollable Ribbon Fiber	Other Products	Pre-term 19-in. Fiber	Pre-term FACT ODF Fiber	FiberGuide	Cable Mgmt Wire Baskets	Category 6A	Powered Fiber	DIN Rail	Fiber Wall Boxes	2 Post Equipment	imVision
------	----------	------	-------------------------------	----------	---------------	-----------------------	----------------	-----------------------	-------------------------	------------	-------------------------	-------------	---------------	----------	------------------	------------------	----------

Architecture System Selection Index

Colocation Campus and Building Infrastructure

Fiber Entrance, Meet-Me Room	High Fiber Count DC Interconnect	Campus Cabling	Building Cabling	IDF to Customer Cage (FACT ODF)	IDF to Customer Cage (19-in. Cabinet)	Campus Cabling for Wi-Fi and Security	MDA Fiber	EDA Fiber	EDA Copper	FiberGuide	MDA Cabinet	MDA Cross-connect 19-in.	MDA Cross-connect FACT ODF	IDF FACT	IDF 19-in.
------------------------------	----------------------------------	----------------	------------------	---------------------------------	---------------------------------------	---------------------------------------	-----------	-----------	------------	------------	-------------	--------------------------	----------------------------	----------	------------

Customer Space Cabling Infrastructure

Reference Designs and Technical Information



Select a product for more information.

19-in. IDF to Customer Cage: Splice Scenario

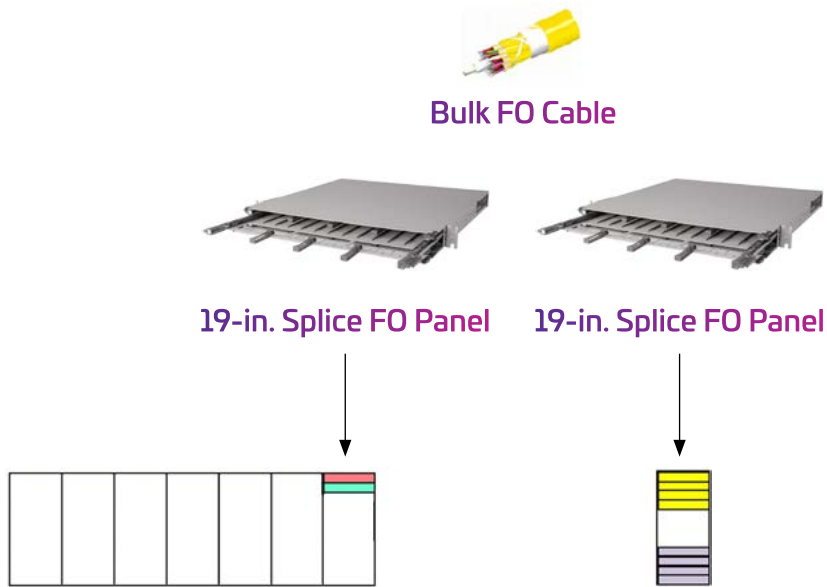

19-in. IDF to Customer Cage: MPO Pre-terminated Scenario

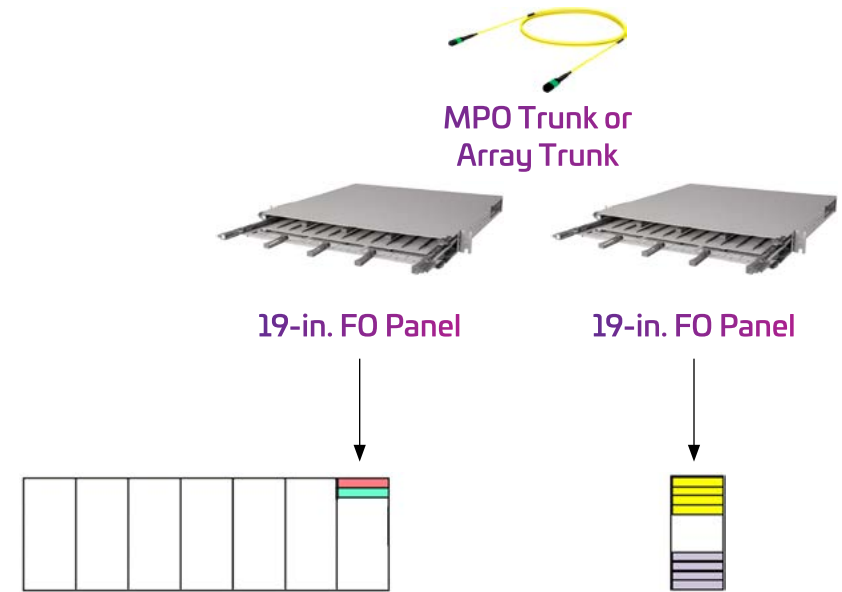

Direct System Selection Index

BUDI	FACT ODF	UMSC	Flex Frame ODF, 19-in. Propel	FOSC 600	19-in. Splice	Rollable Ribbon Fiber	Other Products	Pre-term 19-in. Fiber	Pre-term FACT ODF Fiber	FiberGuide	Cable Mgmt Wire Baskets	Category 6A	Powered Fiber	DIN Rail	Fiber Wall Boxes	2 Post Equipment	imVision
------	----------	------	-------------------------------	----------	---------------	-----------------------	----------------	-----------------------	-------------------------	------------	-------------------------	-------------	---------------	----------	------------------	------------------	----------

Architecture System Selection Index

Colocation Campus and Building Infrastructure

Fiber Entrance, Meet-Me Room	High Fiber Count DC Interconnect	Campus Cabling	Building Cabling	IDF to Customer Cage (FACT ODF)	IDF to Customer Cage (19-in. Cabinet)	Campus Cabling for Wi-Fi and Security	MDA Fiber	EDA Fiber	EDA Copper	FiberGuide	MDA Cabinet	MDA Cross-connect 19-in.	MDA Cross-connect FACT ODF	IDF FACT	IDF 19-in.
------------------------------	----------------------------------	----------------	------------------	---------------------------------	---------------------------------------	---------------------------------------	-----------	-----------	------------	------------	-------------	--------------------------	----------------------------	----------	------------

Customer Space Cabling Infrastructure

Reference Designs and Technical Information



Select a product for more information.

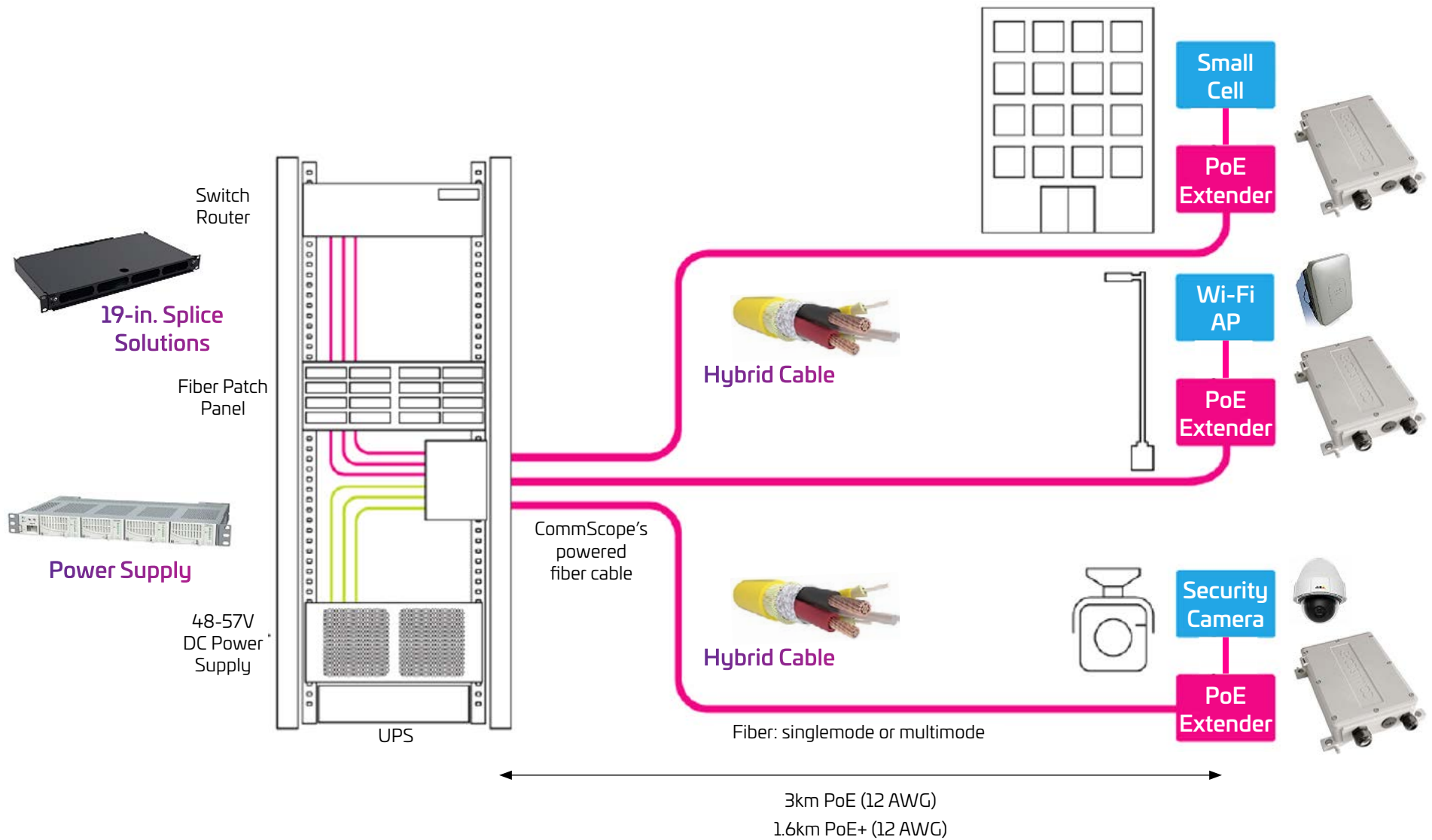

Direct System Selection Index

BUDI	FACT ODF	UMSC	Flex Frame ODF, 19-in. Propel	FOSC 600	19-in. Splice	Rollable Ribbon Fiber	Other Products	Pre-term 19-in. Fiber	Pre-term FACT ODF Fiber	FiberGuide	Cable Mgmt Wire Baskets	Category 6A	Powered Fiber	DIN Rail	Fiber Wall Boxes	2 Post Equipment	imVision
------	----------	------	-------------------------------	----------	---------------	-----------------------	----------------	-----------------------	-------------------------	------------	-------------------------	-------------	---------------	----------	------------------	------------------	----------

Architecture System Selection Index

Colocation Campus and Building Infrastructure

Fiber Entrance, Meet-Me Room	High Fiber Count DC Interconnect	Campus Cabling	Building Cabling	IDF to Customer Cage (FACT ODF)	IDF to Customer Cage (19-in. Cabinet)	Campus Cabling for Wi-Fi and Security	MDA Fiber	EDA Fiber	EDA Copper	FiberGuide	MDA Cabinet	MDA Cross-connect 19-in.	MDA Cross-connect FACT ODF	IDF FACT	IDF 19-in.
------------------------------	----------------------------------	----------------	------------------	---------------------------------	---------------------------------------	---------------------------------------	-----------	-----------	------------	------------	-------------	--------------------------	----------------------------	----------	------------

Customer Space Cabling Infrastructure

Reference Designs and Technical Information



Customer Space Cabling Infrastructure

Overview

Main Distribution Area (MDA) Fiber

Equipment Distribution Area (EDA) Fiber

Equipment Distribution Area (EDA) Copper

FiberGuide® Raceway Systems



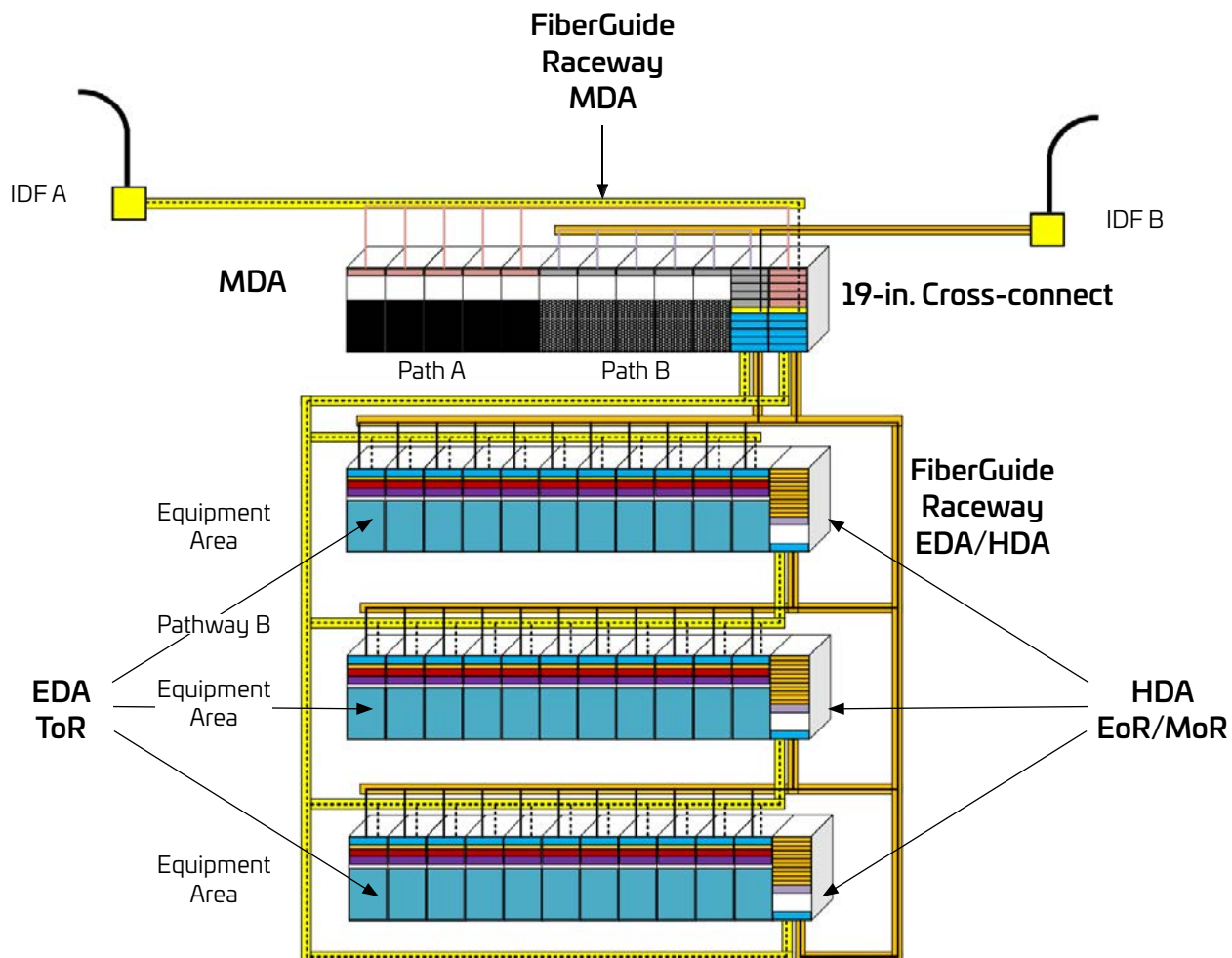
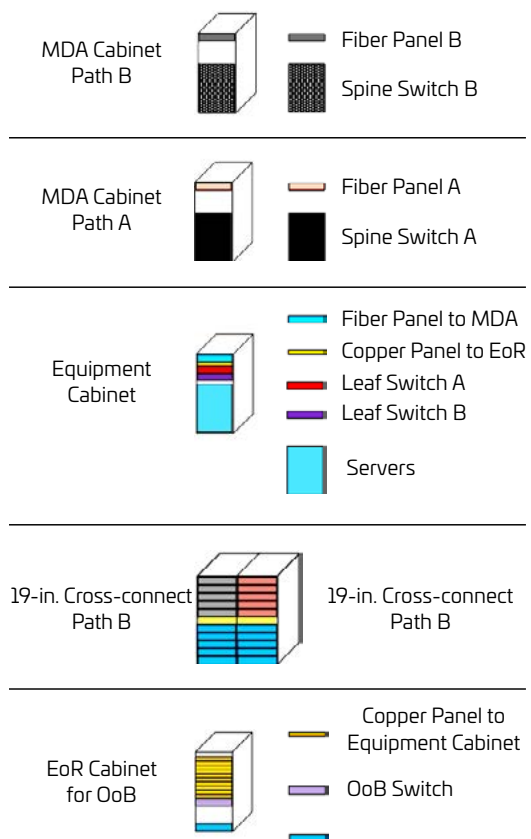

Direct System Selection Index

BUDI	FACT ODF	UMSC	Flex Frame ODF, 19-in. Propel	FOSC 600	19-in. Splice	Rollable Ribbon Fiber	Other Products	Pre-term 19-in. Fiber	Pre-term FACT ODF Fiber	FiberGuide	Cable Mgmt Wire Baskets	Category 6A	Powered Fiber	DIN Rail	Fiber Wall Boxes	2 Post Equipment	imVision
------	----------	------	-------------------------------	----------	---------------	-----------------------	----------------	-----------------------	-------------------------	------------	-------------------------	-------------	---------------	----------	------------------	------------------	----------

Architecture System Selection Index

Colocation Campus and Building Infrastructure

Fiber Entrance, Meet-Me Room	High Fiber Count DC Interconnect	Campus Cabling	Building Cabling	IDF to Customer Cage (FACT ODF)	IDF to Customer Cage (19-in. Cabinet)	Campus Cabling for Wi-Fi and Security	MDA Fiber	EDA Fiber	EDA Copper	FiberGuide	MDA Cabinet	MDA Cross-connect 19-in.	MDA Cross-connect FACT ODF	IDF FACT	IDF 19-in.
------------------------------	----------------------------------	----------------	------------------	---------------------------------	---------------------------------------	---------------------------------------	-----------	-----------	------------	------------	-------------	--------------------------	----------------------------	----------	------------

Customer Space Cabling Infrastructure

Reference Designs and Technical Information



Select a product for more information.

MDA Cabling Channel 19-in. XC

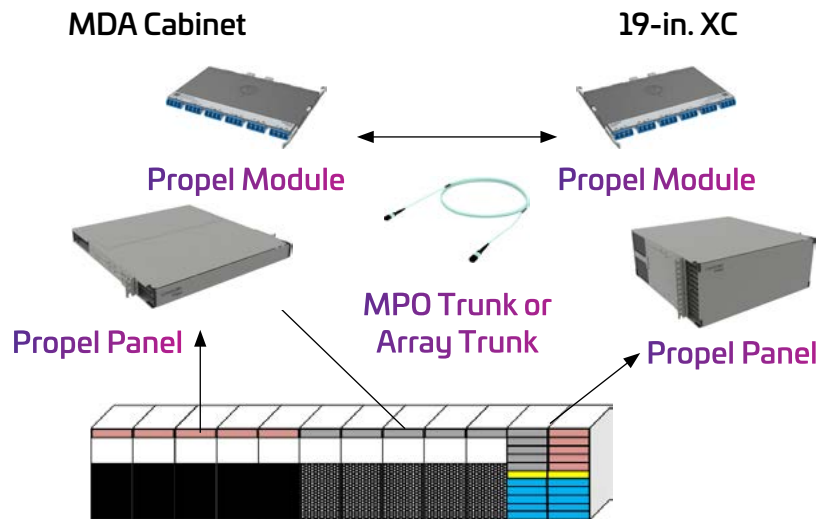

MDA Cabling Channel ODF XC

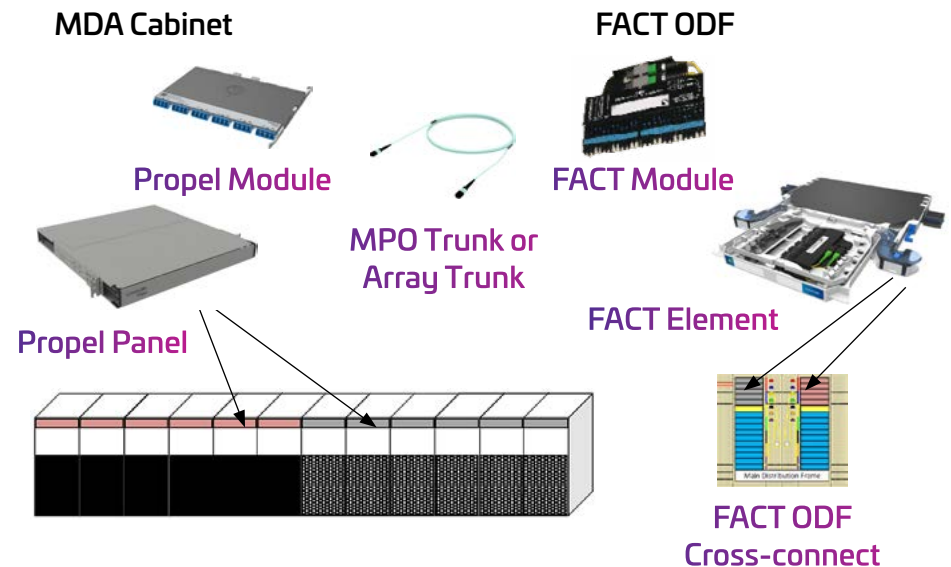

Direct System Selection Index

BUDI	FACT ODF	UMSC	Flex Frame ODF, 19-in. Propel	FOSC 600	19-in. Splice	Rollable Ribbon Fiber	Other Products	Pre-term 19-in. Fiber	Pre-term FACT ODF Fiber	FiberGuide	Cable Mgmt Wire Baskets	Category 6A	Powered Fiber	DIN Rail	Fiber Wall Boxes	2 Post Equipment	imVision
------	----------	------	-------------------------------	----------	---------------	-----------------------	----------------	-----------------------	-------------------------	------------	-------------------------	-------------	---------------	----------	------------------	------------------	----------

Architecture System Selection Index

Colocation Campus and Building Infrastructure

Fiber Entrance, Meet-Me Room	High Fiber Count DC Interconnect	Campus Cabling	Building Cabling	IDF to Customer Cage (FACT ODF)	IDF to Customer Cage (19-in. Cabinet)	Campus Cabling for Wi-Fi and Security	MDA Fiber	EDA Fiber	EDA Copper	FiberGuide	MDA Cabinet	MDA Cross-connect 19-in.	MDA Cross-connect FACT ODF	IDF FACT	IDF 19-in.
------------------------------	----------------------------------	----------------	------------------	---------------------------------	---------------------------------------	---------------------------------------	-----------	-----------	------------	------------	-------------	--------------------------	----------------------------	----------	------------

Customer Space Cabling Infrastructure

Reference Designs and Technical Information



Select a product for more information.

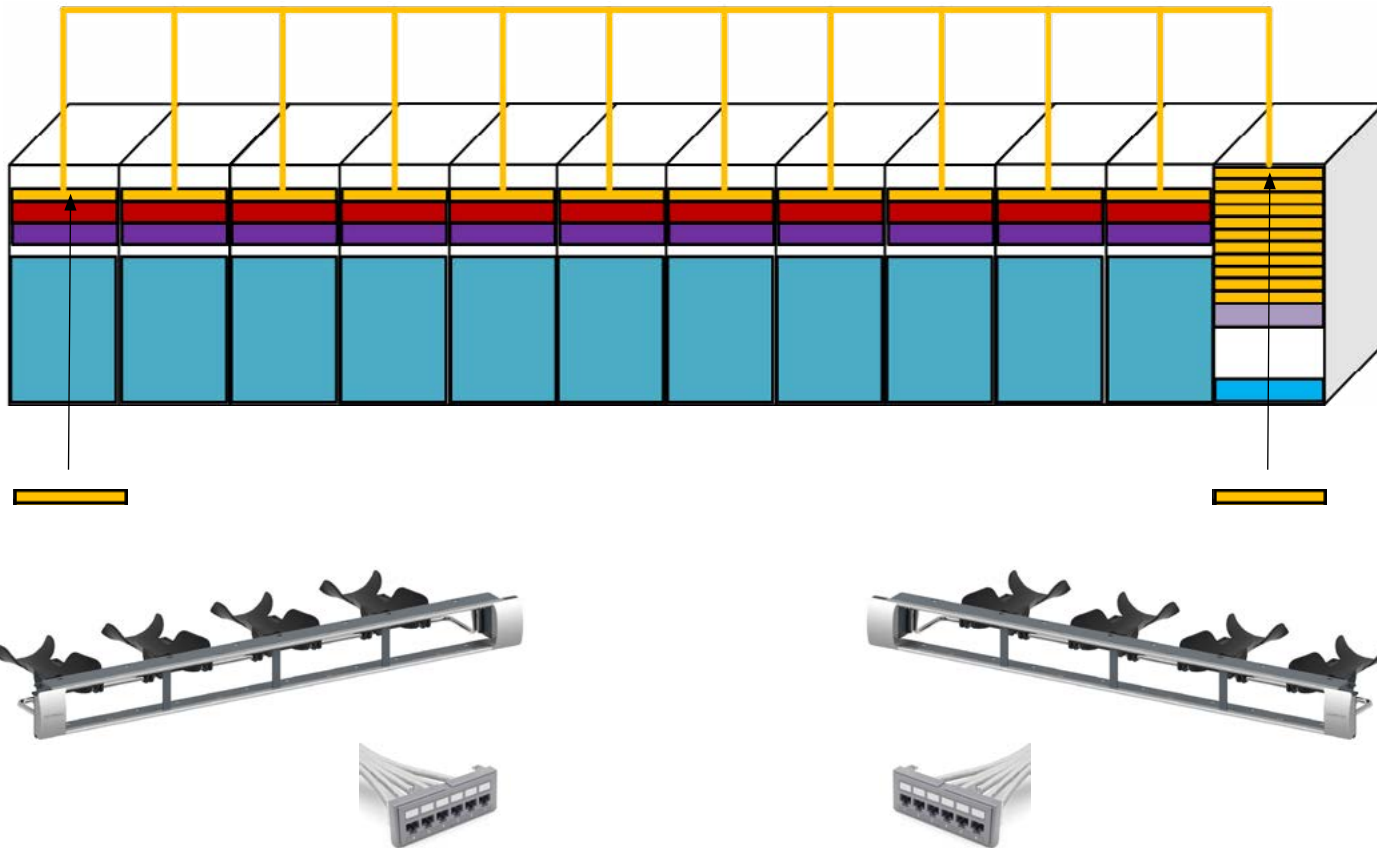
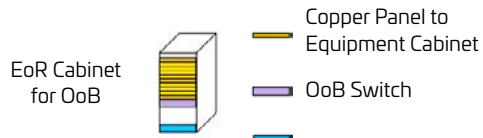

Direct System Selection Index

BUDI	FACT ODF	UMSC	Flex Frame ODF, 19-in. Propel	FOSC 600	19-in. Splice	Rollable Ribbon Fiber	Other Products	Pre-term 19-in. Fiber	Pre-term FACT ODF Fiber	FiberGuide	Cable Mgmt Wire Baskets	Category 6A	Powered Fiber	DIN Rail	Fiber Wall Boxes	2 Post Equipment	imVision
------	----------	------	-------------------------------	----------	---------------	-----------------------	----------------	-----------------------	-------------------------	------------	-------------------------	-------------	---------------	----------	------------------	------------------	----------

Architecture System Selection Index

Colocation Campus and Building Infrastructure

Fiber Entrance, Meet-Me Room	High Fiber Count DC Interconnect	Campus Cabling	Building Cabling	IDF to Customer Cage (FACT ODF)	IDF to Customer Cage (19-in. Cabinet)	Campus Cabling for Wi-Fi and Security	MDA Fiber	EDA Fiber	EDA Copper	FiberGuide	MDA Cabinet	MDA Cross-connect 19-in.	MDA Cross-connect FACT ODF	IDF FACT	IDF 19-in.
------------------------------	----------------------------------	----------------	------------------	---------------------------------	---------------------------------------	---------------------------------------	-----------	-----------	------------	------------	-------------	--------------------------	----------------------------	----------	------------

Customer Space Cabling Infrastructure

Reference Designs and Technical Information



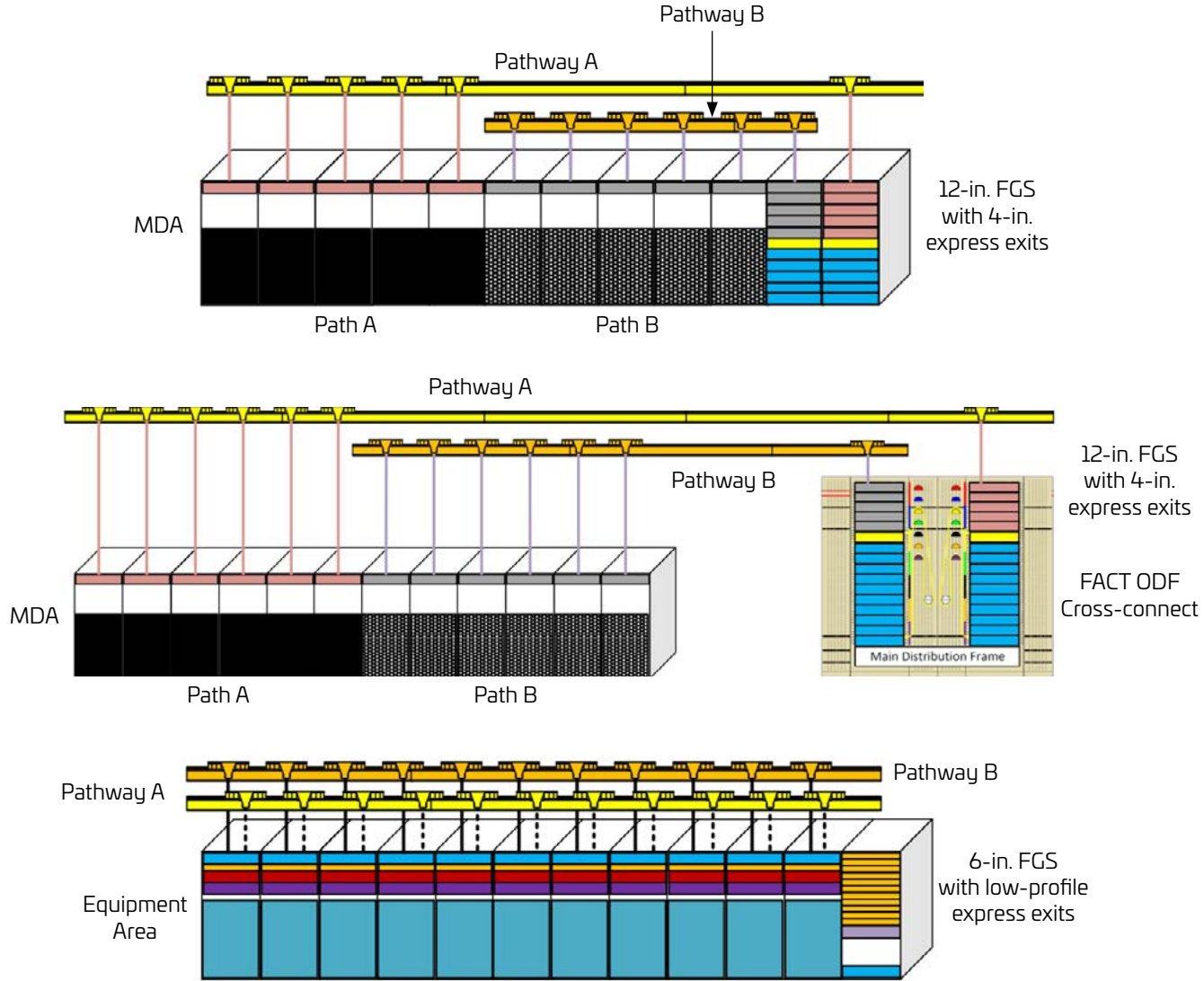

Direct System Selection Index

BUDI	FACT ODF	UMSC	Flex Frame ODF, 19-in. Propel	FOSC 600	19-in. Splice	Rollable Ribbon Fiber	Other Products	Pre-term 19-in. Fiber	Pre-term FACT ODF Fiber	FiberGuide	Cable Mgmt Wire Baskets	Category 6A	Powered Fiber	DIN Rail	Fiber Wall Boxes	2 Post Equipment	imVision
------	----------	------	-------------------------------	----------	---------------	-----------------------	----------------	-----------------------	-------------------------	------------	-------------------------	-------------	---------------	----------	------------------	------------------	----------

Architecture System Selection Index

Colocation Campus and Building Infrastructure

Fiber Entrance, Meet-Me Room	High Fiber Count DC Interconnect	Campus Cabling	Building Cabling	IDF to Customer Cage (FACT ODF)	IDF to Customer Cage (19-in. Cabinet)	Campus Cabling for Wi-Fi and Security
------------------------------	----------------------------------	----------------	------------------	---------------------------------	---------------------------------------	---------------------------------------

Customer Space Cabling Infrastructure

MDA Fiber	EDA Fiber	EDA Copper	FiberGuide
-----------	-----------	------------	------------

Reference Designs and Technical Information

MDA Cabinet	MDA Cross-connect 19-in.	MDA Cross-connect FACT ODF	IDF FACT	IDF 19-in.
-------------	--------------------------	----------------------------	----------	------------



Reference Designs and Technical Information

MDA Cabinet

MDA Cross-connect 19-in.

MDA Cross-connect FACT ODF

IDF FACT

IDF 19-in.



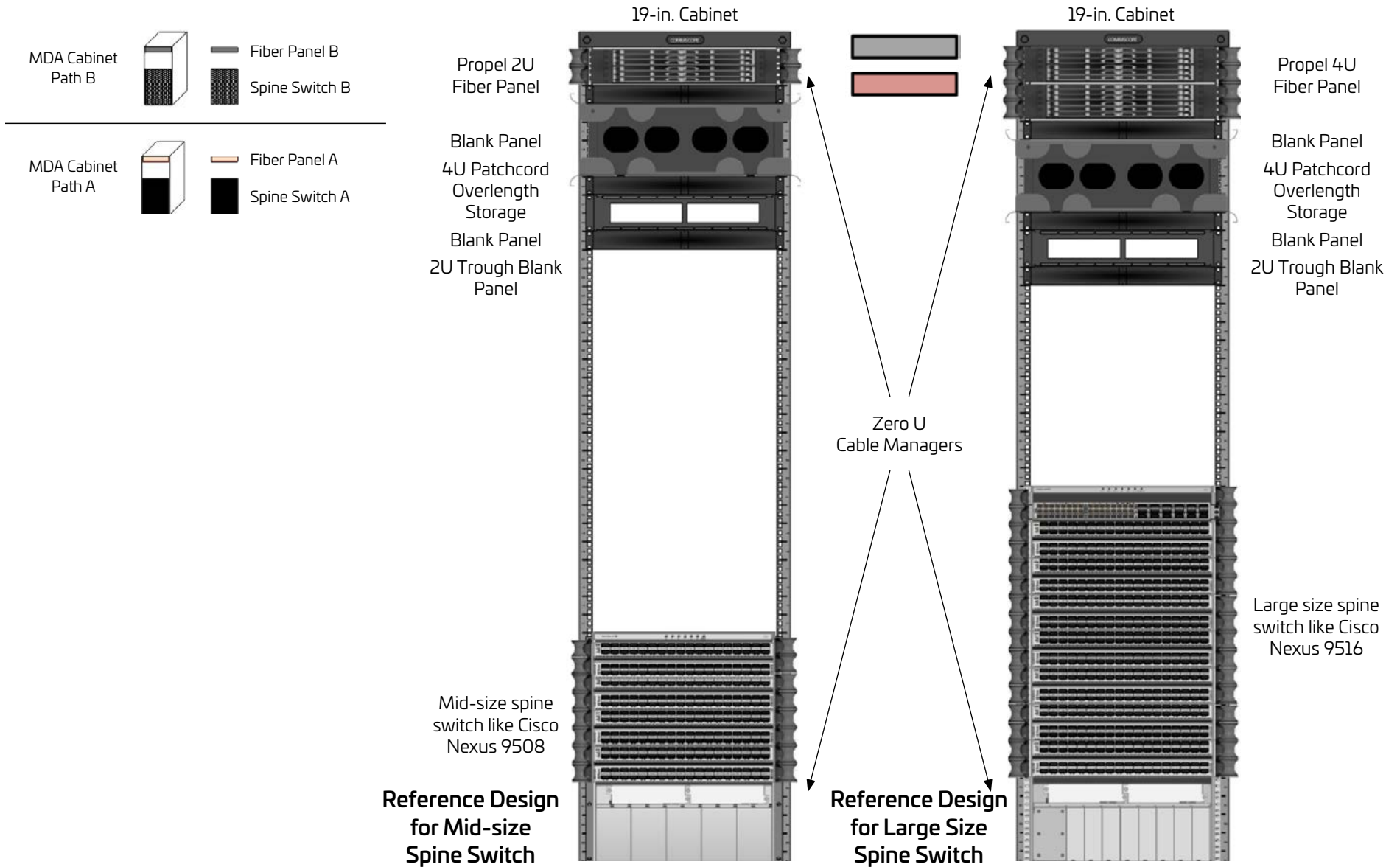

Direct System Selection Index

BUDI	FACT ODF	UMSC	Flex Frame ODF, 19-in. Propel	FOSC 600	19-in. Splice	Rollable Ribbon Fiber	Other Products	Pre-term 19-in. Fiber	Pre-term FACT ODF Fiber	FiberGuide	Cable Mgmt Wire Baskets	Category 6A	Powered Fiber	DIN Rail	Fiber Wall Boxes	2 Post Equipment	imVision
------	----------	------	-------------------------------	----------	---------------	-----------------------	----------------	-----------------------	-------------------------	------------	-------------------------	-------------	---------------	----------	------------------	------------------	----------

Architecture System Selection Index

Colocation Campus and Building Infrastructure							Customer Space Cabling Infrastructure					Reference Designs and Technical Information					
Fiber Entrance, Meet-Me Room	High Fiber Count DC Interconnect	Campus Cabling	Building Cabling	IDF to Customer Cage (FACT ODF)	IDF to Customer Cage (19-in. Cabinet)	Campus Cabling for Wi-Fi and Security	MDA Fiber	EDA Fiber	EDA Copper	FiberGuide	MDA Cabinet	MDA Cross-connect 19-in.	MDA Cross-connect FACT ODF	IDF FACT	IDF 19-in.		



19-in. Cross-connect Path B



19-in. Cross-connect Path B

19-in. Cabinet

3 x Propel Panels 4U
Patch section 1

Blank Panel

Overlength Storage 4U

Blank Panel

3 x Propel Panels 4U
Patch Section 2

Blank Panel

Overlength Storage 4U

Blank Panel

Cable Trough 2U to guide patch cords to adjacent cabinets

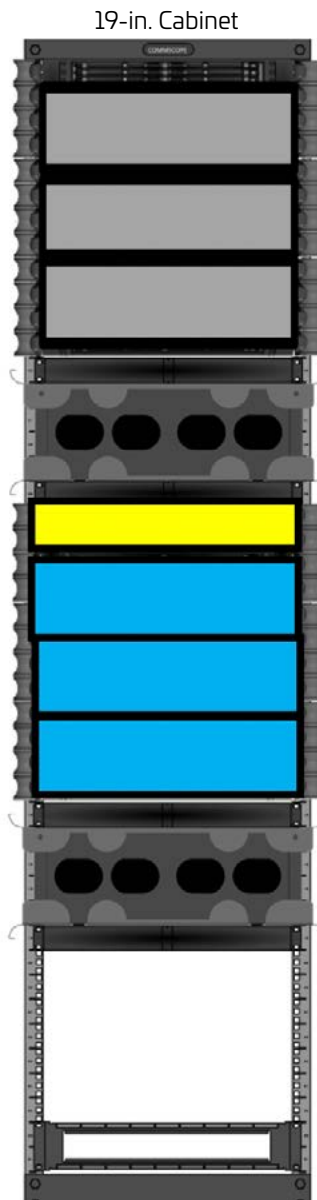

19-in. Cabinet

3 x Propel Panels 4U
Patch section 1

Blank Panel

Overlength Storage 4U

Blank Panel

3 x Propel Panels 4U
Patch Section 2

Blank Panel

Overlength Storage 4U

Blank Panel

Cable Trough 2U to guide patch cords to adjacent cabinets

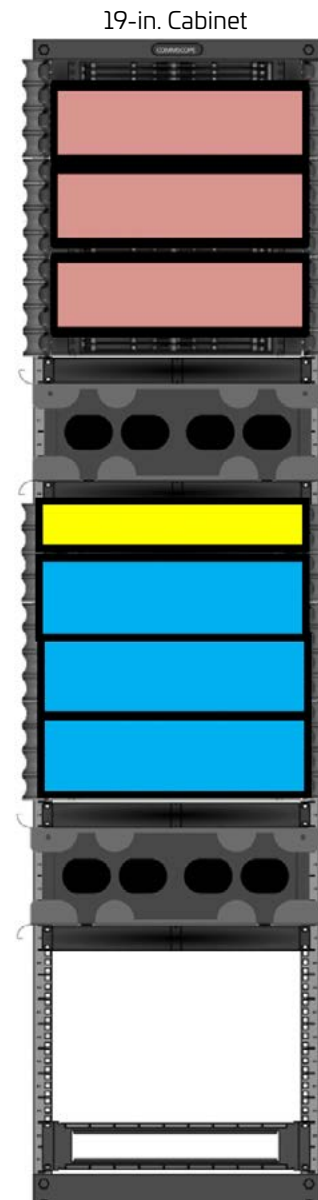

Direct System Selection Index

BUDI	FACT ODF	UMSC	Flex Frame ODF, 19-in. Propel	FOSC 600	19-in. Splice	Rollable Ribbon Fiber	Other Products	Pre-term 19-in. Fiber	Pre-term FACT ODF Fiber	FiberGuide	Cable Mgmt Wire Baskets	Category 6A	Powered Fiber	DIN Rail	Fiber Wall Boxes	2 Post Equipment	imVision
------	----------	------	-------------------------------	----------	---------------	-----------------------	----------------	-----------------------	-------------------------	------------	-------------------------	-------------	---------------	----------	------------------	------------------	----------

Architecture System Selection Index

Colocation Campus and Building Infrastructure

Fiber Entrance, Meet-Me Room	High Fiber Count DC Interconnect	Campus Cabling	Building Cabling	IDF to Customer Cage (FACT ODF)	IDF to Customer Cage (19-in. Cabinet)	Campus Cabling for Wi-Fi and Security
------------------------------	----------------------------------	----------------	------------------	---------------------------------	---------------------------------------	---------------------------------------

Customer Space Cabling Infrastructure

MDA Fiber	EDA Fiber	EDA Copper	FiberGuide
-----------	-----------	------------	------------

Reference Designs and Technical Information

MDA Cabinet	MDA Cross-connect 19-in.	MDA Cross-connect FACT ODF	IDF FACT	IDF 19-in.
-------------	--------------------------	----------------------------	----------	------------



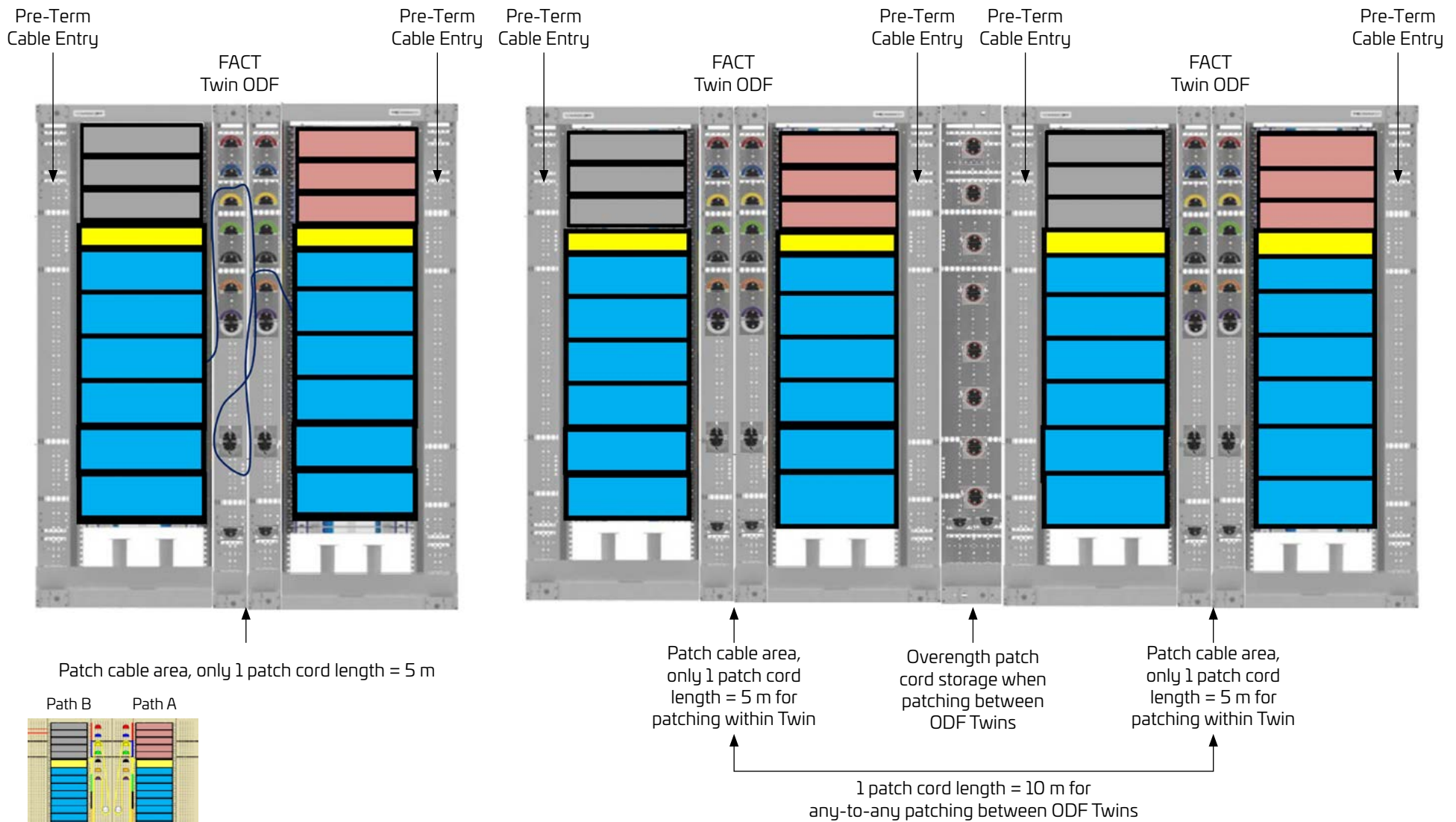

Patch cable area, only 1 patch cord length = 5 m

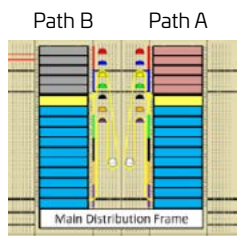

FACT ODF Cross-connect

Note: The XC can consist of more than 4 cabinets depending on the DC size.

Direct System Selection Index

BUDI	FACT ODF	UMSC	Flex Frame ODF, 19-in. Propel	FOSC 600	19-in. Splice	Rollable Ribbon Fiber	Other Products	Pre-term 19-in. Fiber	Pre-term FACT ODF Fiber	FiberGuide	Cable Mgmt Wire Baskets	Category 6A	Powered Fiber	DIN Rail	Fiber Wall Boxes	2 Post Equipment	imVision
------	----------	------	-------------------------------	----------	---------------	-----------------------	----------------	-----------------------	-------------------------	------------	-------------------------	-------------	---------------	----------	------------------	------------------	----------

Architecture System Selection Index

Colocation Campus and Building Infrastructure

Fiber Entrance, Meet-Me Room	High Fiber Count DC Interconnect	Campus Cabling	Building Cabling	IDF to Customer Cage (FACT ODF)	IDF to Customer Cage (19-in. Cabinet)	Campus Cabling for Wi-Fi and Security	MDA Fiber	EDA Fiber	EDA Copper	FiberGuide	MDA Cabinet	MDA Cross-connect 19-in.	MDA Cross-connect FACT ODF	IDF FACT	IDF 19-in.
------------------------------	----------------------------------	----------------	------------------	---------------------------------	---------------------------------------	---------------------------------------	-----------	-----------	------------	------------	-------------	--------------------------	----------------------------	----------	------------

Customer Space Cabling Infrastructure

Reference Designs and Technical Information



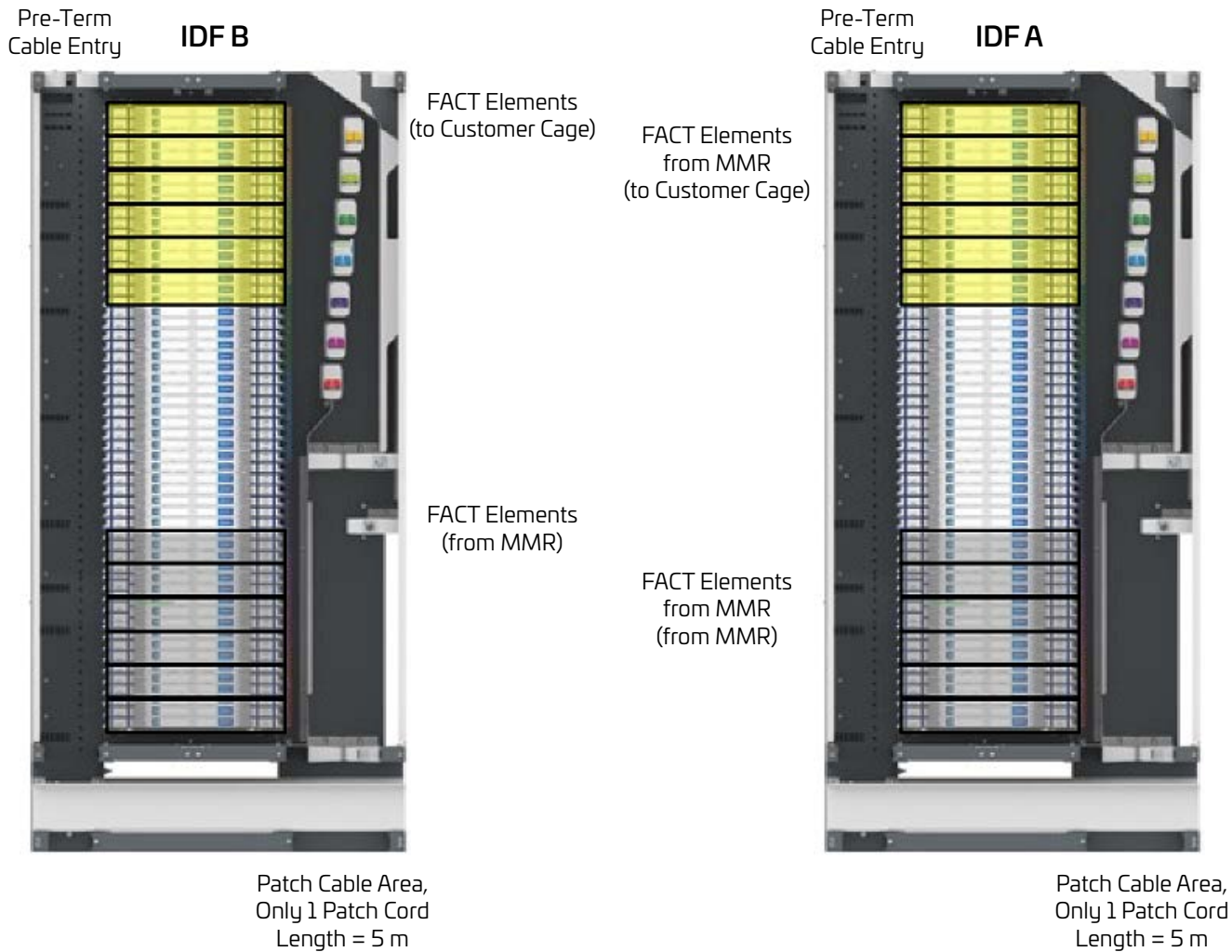

Direct System Selection Index

BUDI	FACT ODF	UMSC	Flex Frame ODF, 19-in. Propel	FOSC 600	19-in. Splice	Rollable Ribbon Fiber	Other Products	Pre-term 19-in. Fiber	Pre-term FACT ODF Fiber	FiberGuide	Cable Mgmt Wire Baskets	Category 6A	Powered Fiber	DIN Rail	Fiber Wall Boxes	2 Post Equipment	imVision
------	----------	------	-------------------------------	----------	---------------	-----------------------	----------------	-----------------------	-------------------------	------------	-------------------------	-------------	---------------	----------	------------------	------------------	----------

Architecture System Selection Index

Colocation Campus and Building Infrastructure

Fiber Entrance, Meet-Me Room	High Fiber Count DC Interconnect	Campus Cabling	Building Cabling	IDF to Customer Cage (FACT ODF)	IDF to Customer Cage (19-in. Cabinet)	Campus Cabling for Wi-Fi and Security
------------------------------	----------------------------------	----------------	------------------	---------------------------------	---------------------------------------	---------------------------------------

Customer Space Cabling Infrastructure

MDA Fiber	EDA Fiber	EDA Copper	FiberGuide
-----------	-----------	------------	------------

Reference Designs and Technical Information

MDA Cabinet	MDA Cross-connect 19-in.	MDA Cross-connect FACT ODF	IDF FACT	IDF 19-in.
-------------	--------------------------	----------------------------	----------	------------



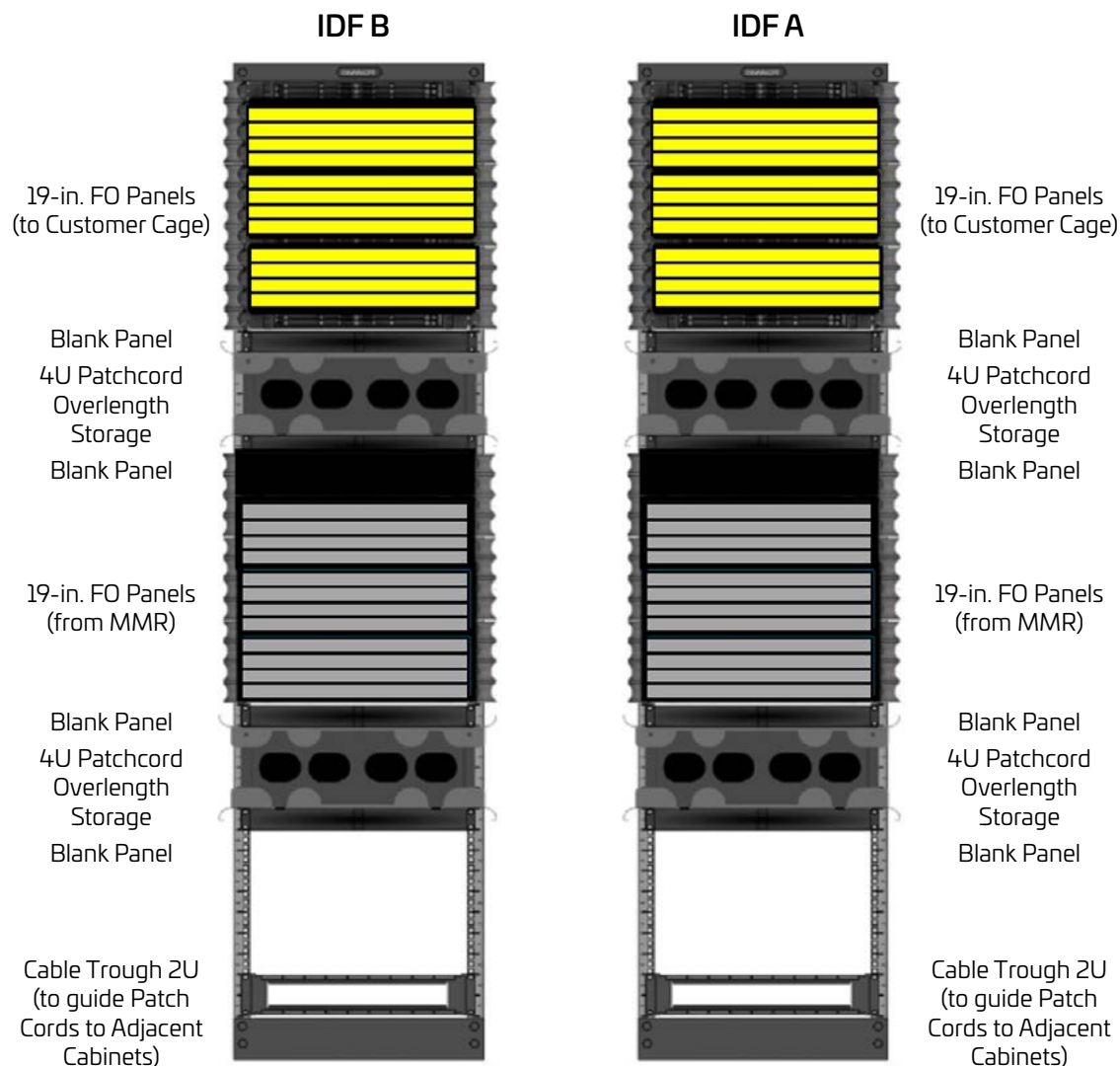
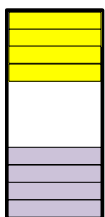

Direct System Selection Index

BUDI	FACT ODF	UMSC	Flex Frame ODF, 19-in. Propel	FOSC 600	19-in. Splice	Rollable Ribbon Fiber	Other Products	Pre-term 19-in. Fiber	Pre-term FACT ODF Fiber	FiberGuide	Cable Mgmt Wire Baskets	Category 6A	Powered Fiber	DIN Rail	Fiber Wall Boxes	2 Post Equipment	imVision
------	----------	------	-------------------------------	----------	---------------	-----------------------	----------------	-----------------------	-------------------------	------------	-------------------------	-------------	---------------	----------	------------------	------------------	----------

Architecture System Selection Index

Colocation Campus and Building Infrastructure

Fiber Entrance, Meet-Me Room	High Fiber Count DC Interconnect	Campus Cabling	Building Cabling	IDF to Customer Cage (FACT ODF)	IDF to Customer Cage (19-in. Cabinet)
------------------------------	----------------------------------	----------------	------------------	---------------------------------	---------------------------------------

Customer Space Cabling Infrastructure

Campus Cabling for Wi-Fi and Security	MDA Fiber	EDA Fiber	EDA Copper	FiberGuide
---------------------------------------	-----------	-----------	------------	------------

Reference Designs and Technical Information

MDA Cabinet	MDA Cross-connect 19-in.	MDA Cross-connect FACT ODF	IDF FACT	IDF 19-in.
-------------	--------------------------	----------------------------	----------	------------



CommScope pushes the boundaries of communications technology with game-changing ideas and ground-breaking discoveries that spark profound human achievement. We collaborate with our customers and partners to design, create and build the world's most advanced networks. It is our passion and commitment to identify the next opportunity and realize a better tomorrow. Discover more at commscope.com.

COMMSCOPE®

commscope.com

Visit our website or contact your local CommScope representative for more information.

© 2023 CommScope, Inc. All rights reserved.

CommScope and the CommScope logo are registered trademarks of CommScope and/or its affiliates in the U.S. and other countries. For additional trademark information see www.commscope.com/trademarks. All product names, trademarks and registered trademarks are property of their respective owners. This document is for planning purposes only and is not intended to modify or supplement any specifications or warranties relating to CommScope products or services. CommScope is committed to the highest standards of business integrity and environmental sustainability, with a number of CommScope's facilities across the globe certified in accordance with international standards, including ISO 9001, TL 9000, and ISO 14001. Further information regarding CommScope's commitment can be found at www.commscope.com/corporate-responsibility-and-sustainability.

EB-1175611-EN (11/23)

